

APPLICATIONS

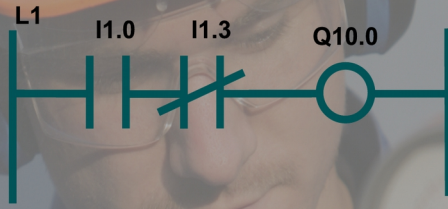

REAL WORLD WIRELESS APPLICATIONS

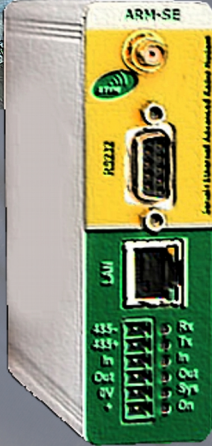

INDUSTRIAL RADIOS

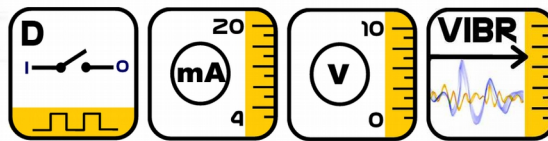
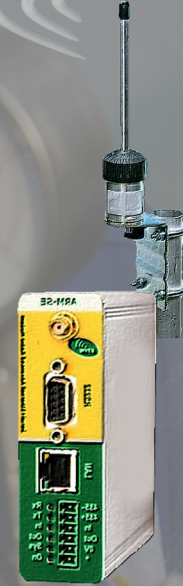

INDUSTRIAL WIRELESS

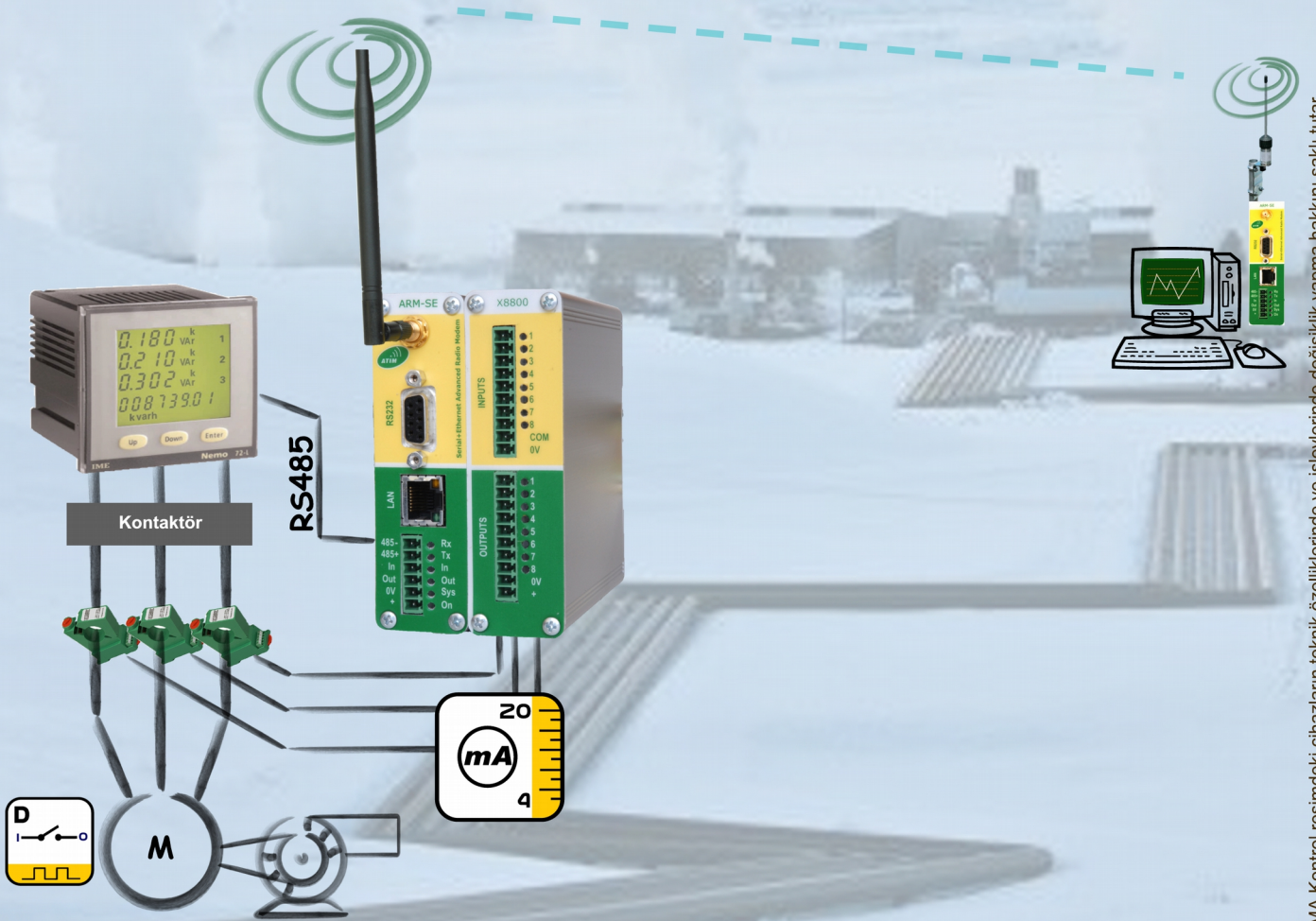

WIRELESS EMERGENCY SHOWER MONITORING

NASIL ÇALIŞIR !

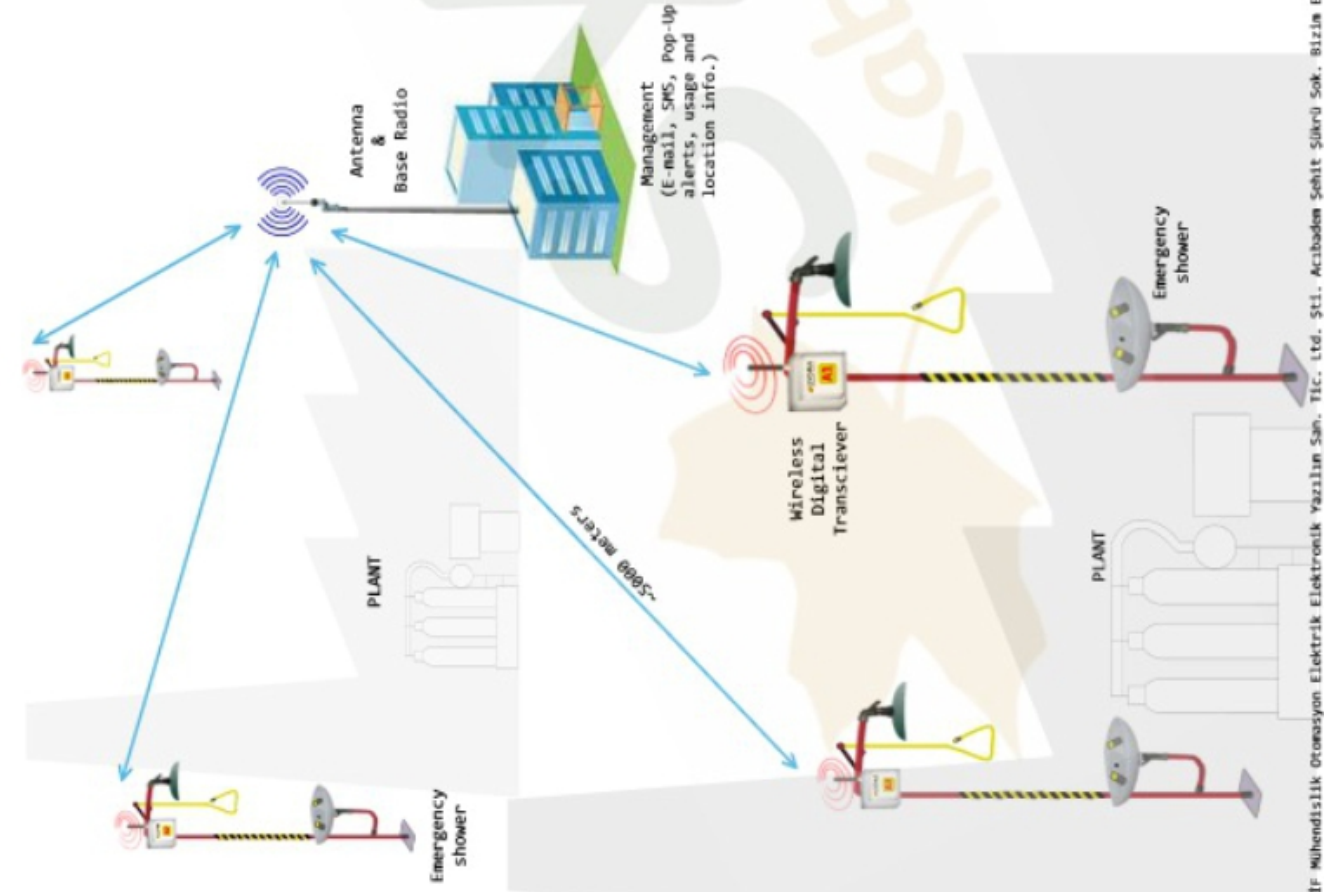

1

Sahadaki acil temizleme duşlarından biri kullanılmaktadır. Artık zaman çok değerlidir.



2

Dijital kablosuz verici bu kullanımı güvenilir bir kablosuz bağlantı üzerinden rapor eder.



3

Kontrol odası, güvenlik ve sağlık personeli, duşun aktifliği ve konumu hakkında, kontrol ekranından anında uyarılır.

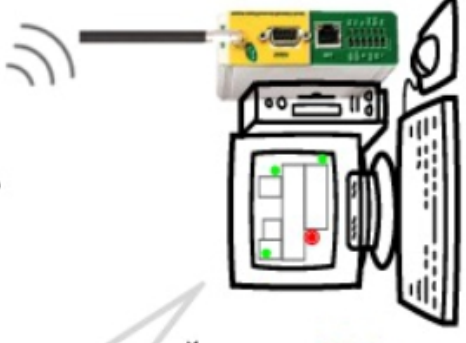

4

Konum bilgisi, sağlık ve güvenlik personelinin en kısa zamanda müdahale edebilmesi için, SMS, e-posta ve ekrandaki uyarı penceresi yolu ile bildirilir.



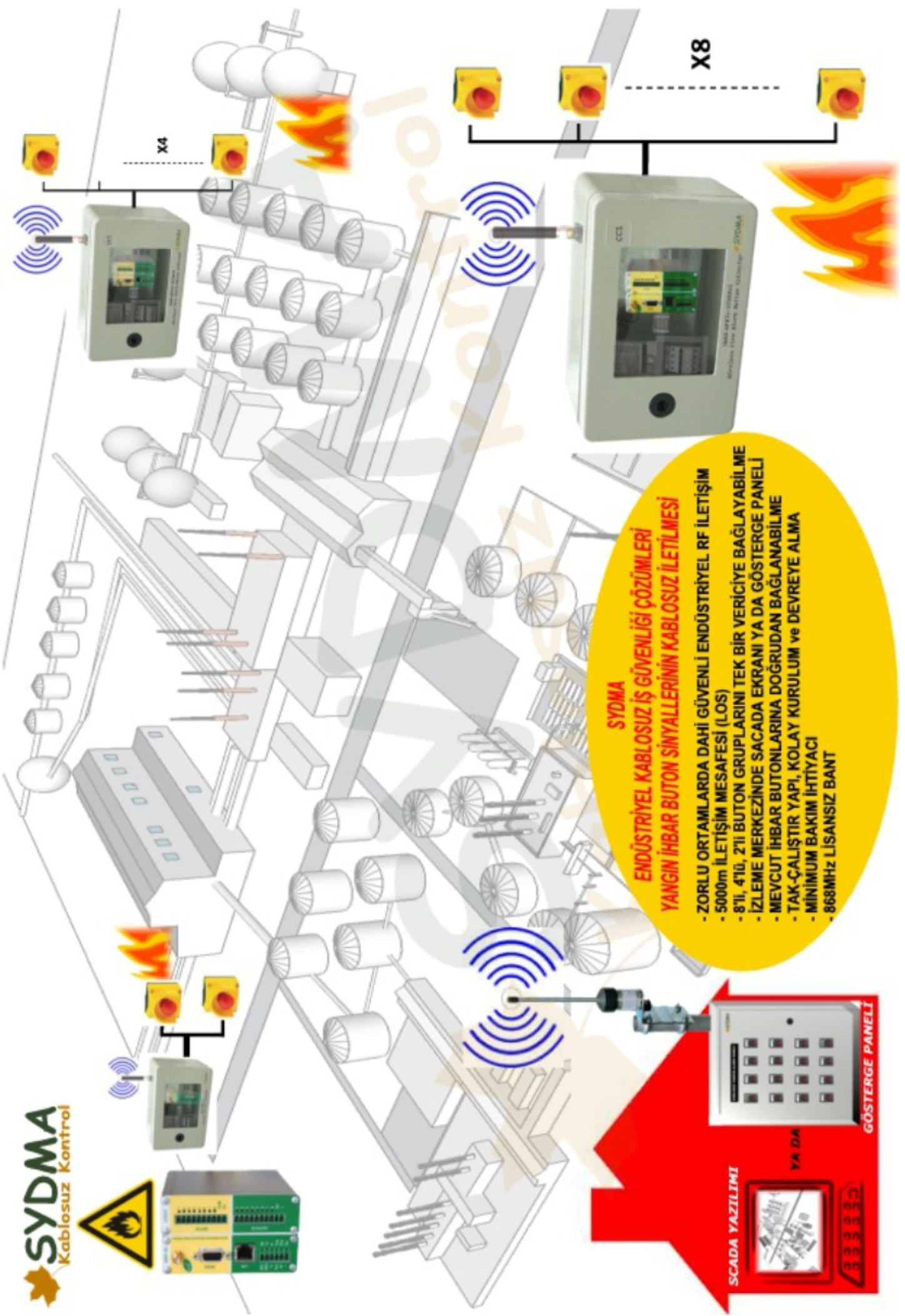

SYDMA

ENDÜSTRİYEL KABLOSUZ İŞ GÜVENLİĞİ ÇÖZÜMLERİ YANGIN İHBAR BUTON SINYALLERİNİN KABLOSUZ İLETİLMESİ

- ZORLU ORTAMLARDA DAHI GÜVENLİ ENDÜSTRİYEL RF İLETİŞİM
- 5000m İLETİŞİM MESAFESİ (LOS)
- 8"İ, 4"İ, 2"İ BUTON GRUPLARINI TEK BİR VERİÇİYE BAĞLAYABİLME
- İZLEME MERKEZİNDE SACADA EKRANI YA DA GÖSTERGE PANELİ
- MEVCUT İHBAR BUTONLARINA DOĞRUDAN BAĞLANABİLME
- TAK-ÇALIŞTIR YAPI, KOLAY KURULUM ve DEVREYE ALMA
- MINİMUM BAKIM İHTİYACI
- 868MHz LİSANSIZ BANT

SCADA YAZILIHI

YA DA

333333

GÖSTERGE PANELİ

X8

X4

KORUYUCU - KESTİRİMCİ BAKIM UYGULAMALARI

ELEKTRİK MOTORLARININ ÇALIŞMA PARAMETRELERİNİN
KABLOSUZ OLARAK İZLENMESİ

MODBUS

>5 Km
NLOS
868 MHz
500mW !

İzlenebilen Motor Çalışma Parametreleri;

- Akım
- Gerilim
- Güç
- Motor Sıcaklığı
- Yatak, Dişli, Rulman Sıcaklığı
- Motor Arıza (Çalışıyor/Duruyor/Termik)
- Motor Devri

Kontrol;

- Motor Çalıştır/Durdur
- Vana Aç/Kapa !

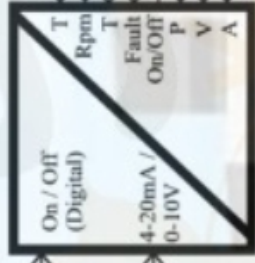

İzleme ve Kontrol
Merkezi

KABLOSUZ PLC HABERLEŞMESİ

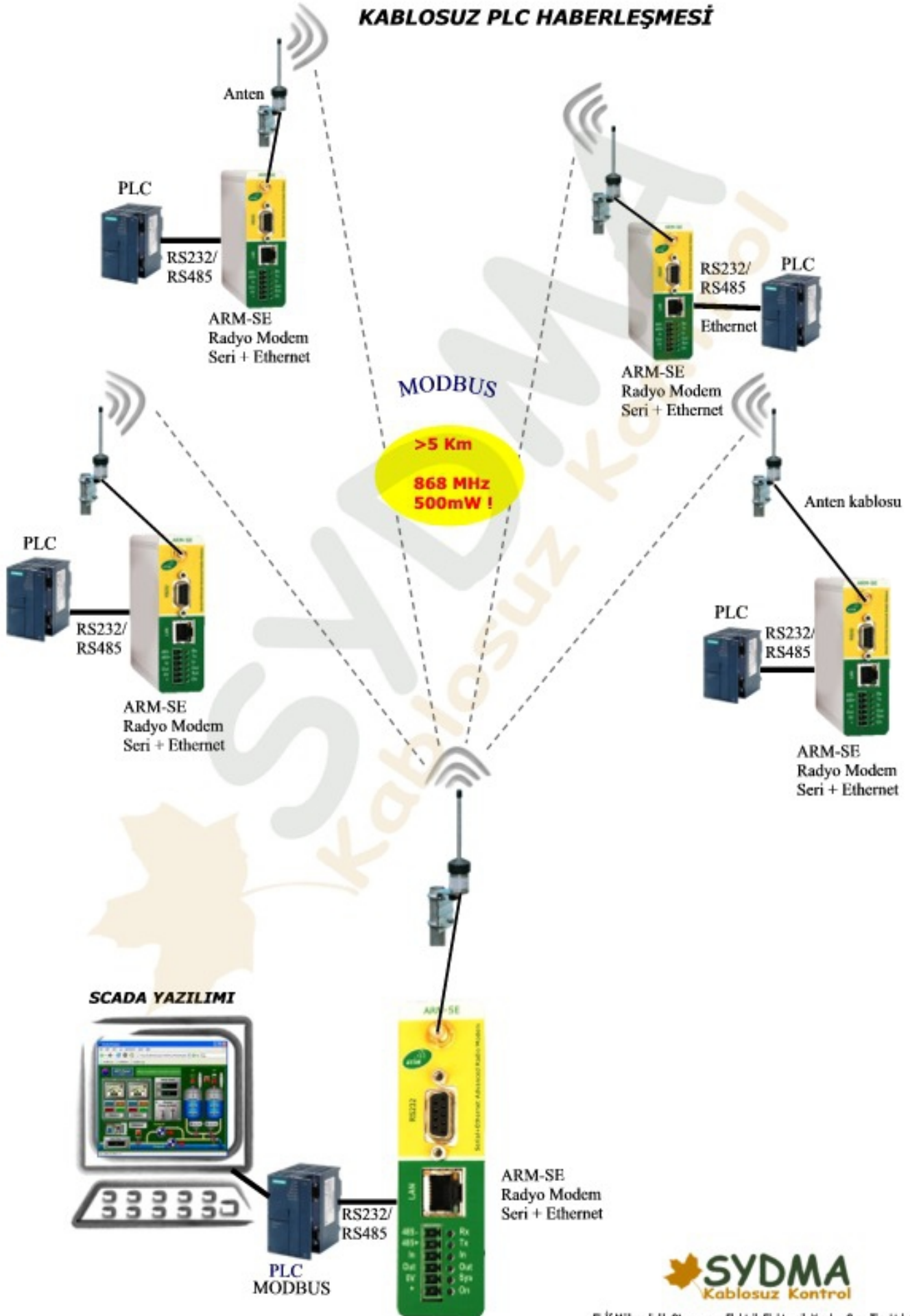

SYDMA
Kablosuz Kontrol

E-İf Mühendislik Otomasyon Elektrik Elektronik Yazılım San. Tic. Ltd. Şti.
Tel: 0216 339 62 47-48 Faks: 0216 327 63 55
www.sydma.com

KABLOSUZ DÖNER MAKİNA/TABLA İZLEME ve KONTROL

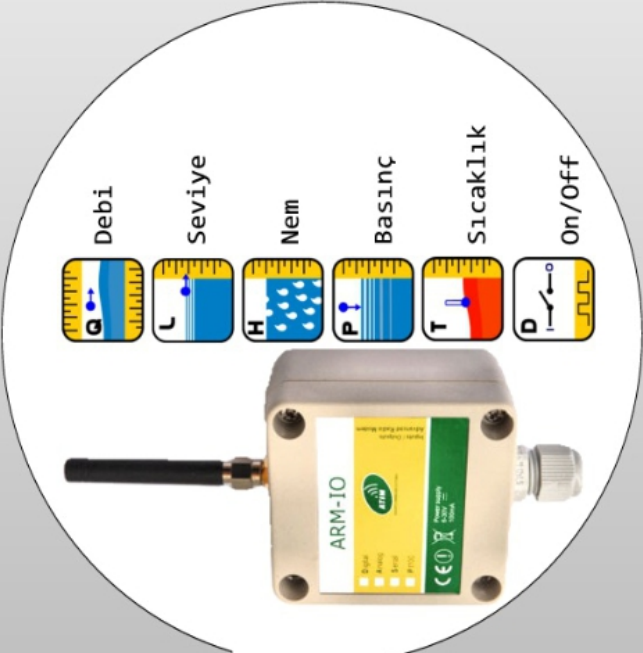
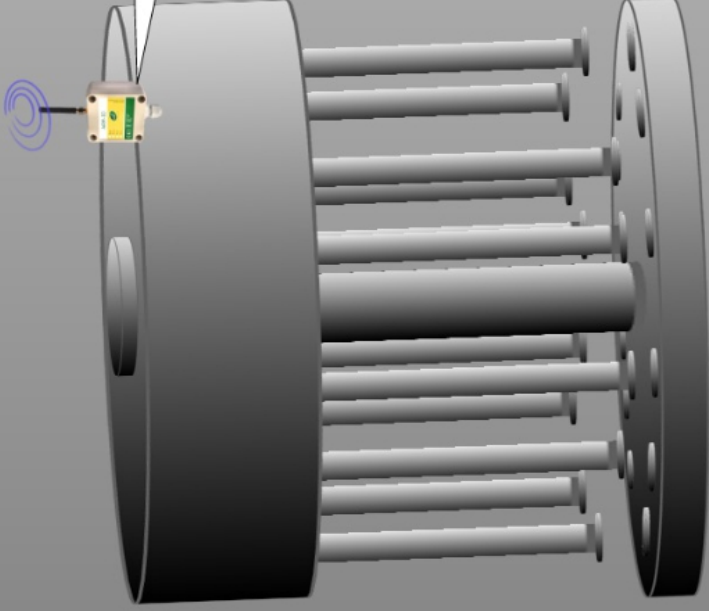

- Bir döner makina ya da tabladan seviye, basınç gibi analog ya da açık-kapalı gibi sayısal bilgilerin kablosuz olarak iletilmesi, kablo ve bilezik kullanımını gerektirmez.
- İşlem verilerinin, kontrol panosuna otomatik olarak gönderilmesi sağlanır.
- Gerektiğinde sistem batarya ile beslenerek tam bağımsız hale getirilebilir. Ölçme sıklığına bağlı olarak, batarya 1 yıla kadar kullanılabilir.
- Kablosuz sistem kullanılması, kablolardan kaynaklanan sorunların ortadan kalkmasını, maliyetli ve bakım gerektiren bileziklerden kurtulmasını ve bakım periyotlarının azalmasını sağlar.
- Kablosuz sistem, döner makinanın devre dışı kalma süresini belirgin bir şekilde azaltarak toplam verimin artmasına yardımcı olur.

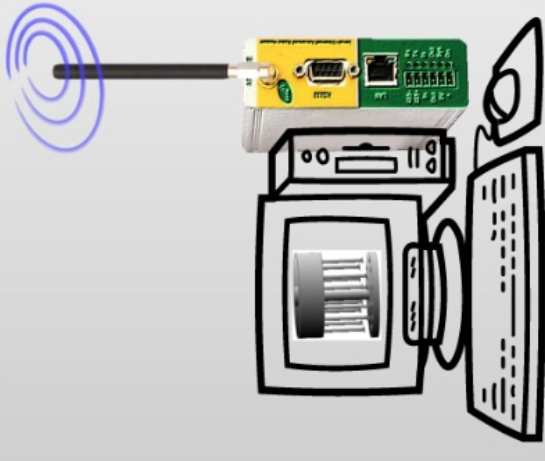

ENDÜSTRİYEL KABLOSUZ UYARI SİSTEMİ



Vinç Panoları:
IP65, röle kontak
çıkışlı.
Merkez ve
iş makineleri ile
kablosuz iletişim.
Sesli Işıklı Uyarı Sistemi

Vinçler

Hol Girişi
(Yaya Uyarısı)

Kepçe
Girişi

İş Makinaları - Kepçeler

Pano
ya da
Kutu
ALICI /VERİCİ :
IP 65
ARM-D: 2 D I/O
868 MHz, 500mW Radio
Sesli Işıklı Uyarı Sistemi

**Water Control Center
Detail**

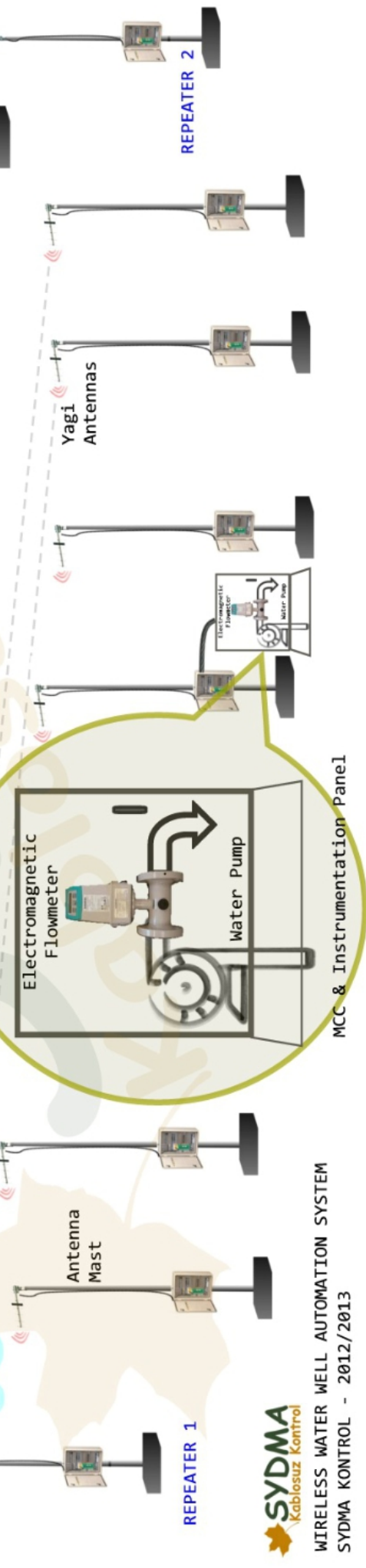
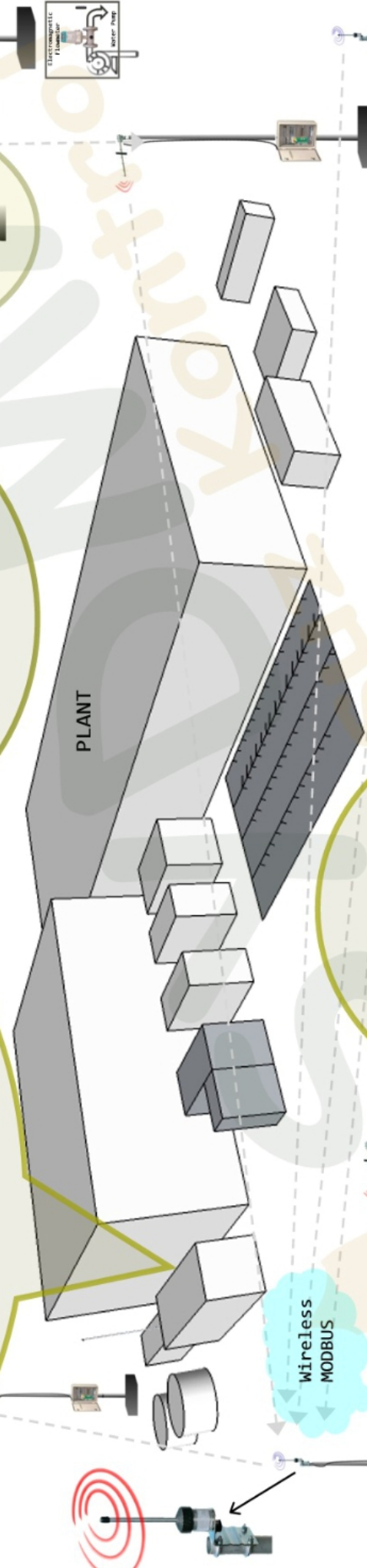
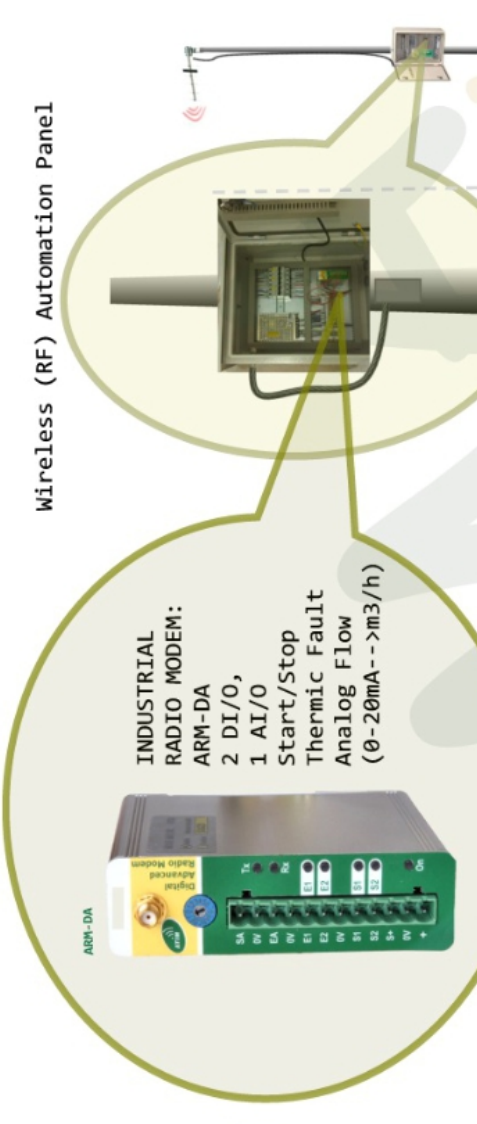
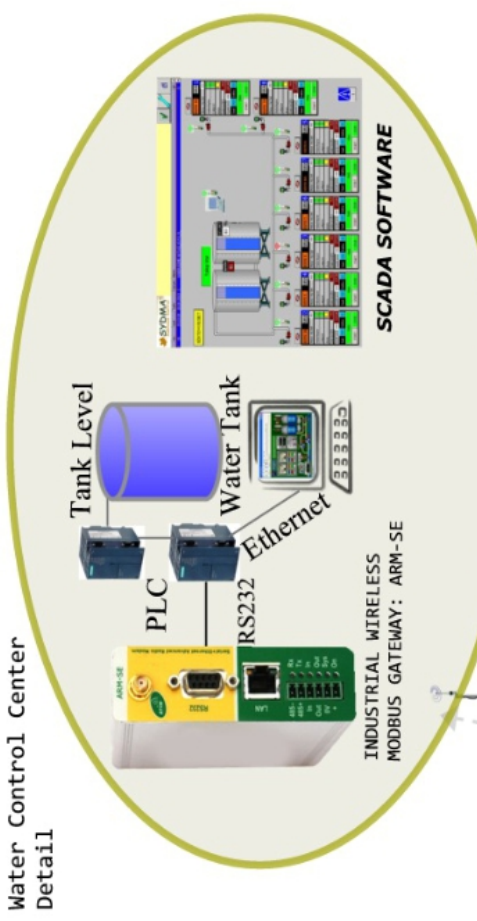

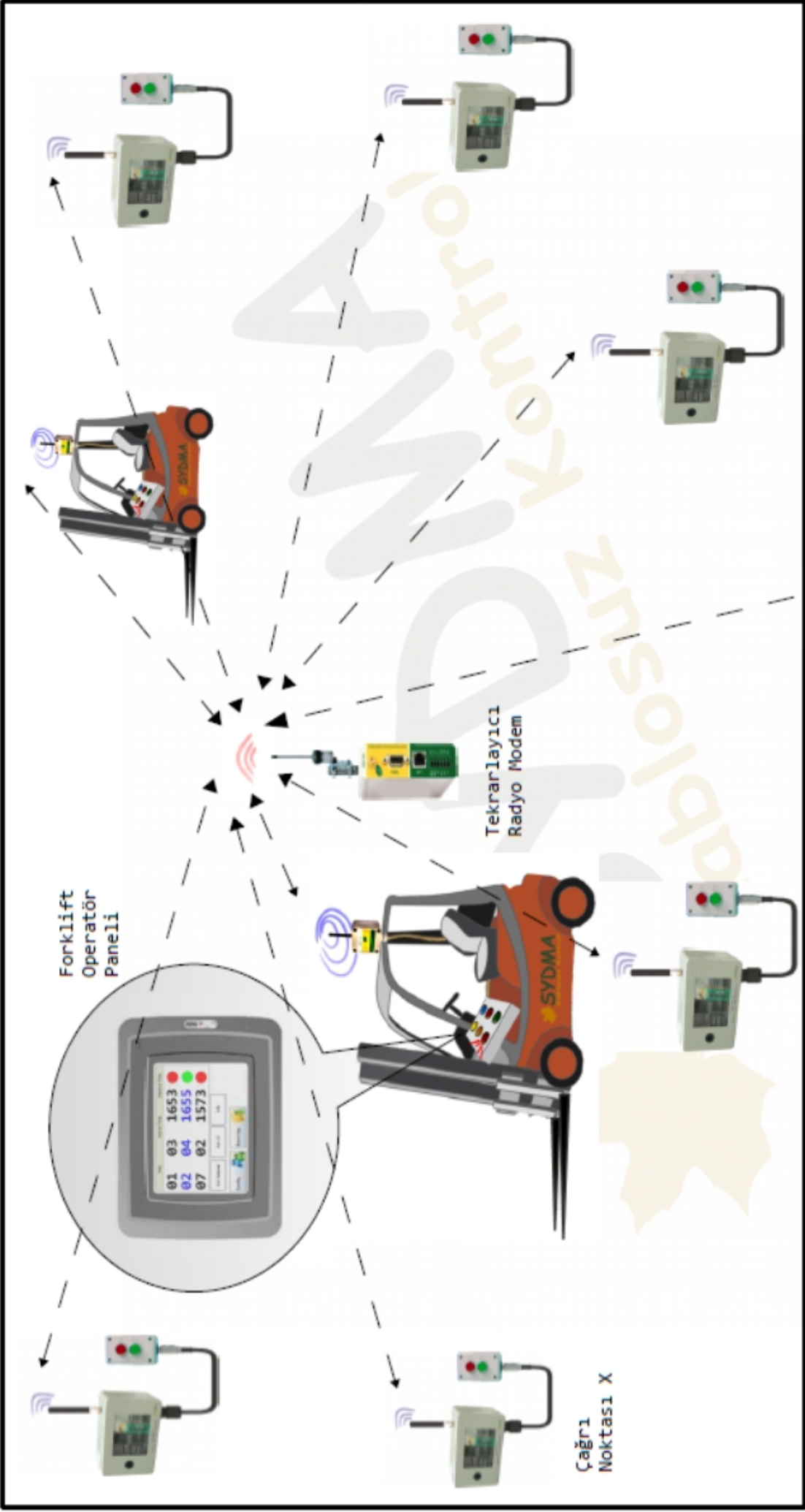

Kablosuz Forklift Yönetim Sistemi

SYDMA
Kablosuz Kontrol

El-İr Mühendislik Otomasyon Elektrik Elektronik Yazılım San. Tic. Ltd. Şti.
Tel: 0216 339 62 47-48 Faks: 0216 327 63 55
www.sydma.com



değer katın.

KABLOSUZ ENDÜSTRİYEL ÇÖZÜMLER



SCADA
Bilgisayarı
(Endüstriyel PC)



Endüstriyel
PLC



Ethernet
Switch



ARM-SE
Seri + Ethernet
Radyo Modem
868MHz - 38400bps
5000m İletişim Mesafesi



WLI-E Kablosuz Ethernet
Endüstriyel Wireless LAN
Access Point - AP
2.4GHz - 11Mbps
300m İletişim Mesafesi

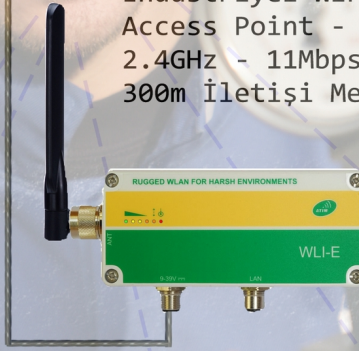

Kontrol Merkezi

Forklift
Çağrı
Sistemi



Büyük İş
Makinaları



Alternatif
Enerji
Sistemleri



AGV'ler ve
Hareketli
Araçlar



Vinçler, Kreyner
Bantlı taşıma
sistemleri



Makine-Tezgah
Makine-Merkez
Makine-Makine



Tüm Sektörler İçin
KABLOSUZ ENDÜSTRİYEL ÇÖZÜMLER

PROSES



ÇİMENTO



KİMYA



CAM



TAŞIMACILIK



ENERJİ ÜRETİMİ



ENERJİ DAĞITIMI



PETROKİMYA



DOĞAL GAZ



GIDA



SPOR



SAĞLIK



PERAKENDE ve BÜYÜK MAĞAZACILIK



TARIM



LOJİSTİK



OTOMOTİV



İNŞAAT



DEPOLAMA



SERACILIK



www.sydma.com

**RADYO MODEM
ENDÜSTRİYEL ETHERNET
GSM/GPRS RTU
KABLOSUZ SCADA
TELEMETRİ
OEM RF MODÜL**

ENDÜSTRİYEL RF MODEM

ENDÜSTRİYEL ETHERNET

GSM/GPRS RTU

KABLOSUZ SENSÖR AĞLARI

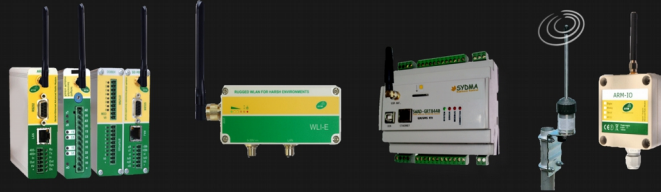

EL-İF Mühendislik Otomasyon Elektrik elektronik Yazılım Sanayi ve Ticaret Ltd. Şti.

Acıbadem Mah. Şehit Şükrü Sok. 2A/A
34660 Üsküdar - İstanbul

Tel : 90 216 339 62 47-48-49
Faks : 90 216 327 63 55

www.sydma.com