



---

Advanced radio modems

---

**Nano transceiver modules**

---

**N8-LD/LP**

---

User Guide



Concerned models:  
ARM-N8-LD (Long distance)  
ARM-N8-LP (Low power)  
ARM-N8-SF (Sigfox)



ATIM Radiocommunications  
Chemin des Guillets  
38250 Villard de Lans

[www.atim.com](http://www.atim.com)  
[info@atim.com](mailto:info@atim.com)



## TABLE OF CONTENTS

Document version history .....	4
Disclaimer.....	4
Trademarks and copyright .....	4
Declaration of compliance .....	5
Environmental recommendations .....	5
Environment .....	5
Radio .....	6
Radio regulations .....	7
i. Context .....	7
ii. Information about the regulation and the conformity .....	7
Generalities .....	9
i. Presentation .....	9
ii. ARM range and ACW range .....	9
iii. Soldering & Environment .....	9
Technical features.....	10
i. Electrical and mechanical characteristics.....	10
ii. Dimensions .....	10
iii. Pins .....	11
iv. Consumption features.....	11
v. Link interfaces .....	12
vi. Firmware update .....	12
vii. RF features .....	13
viii. Delay.....	13
ix. Memory.....	14
Hardware integration.....	15
i. Power supply .....	15
ii. Impedance of the antenna adaption.....	15
iii. Print and ground plan.....	15
AT command configuration.....	16
Test modes .....	17
i. Ping-pong mode (ATT00 and ATT01).....	17
ii. Continuous reception mode (ATT02) .....	17
iii. Pure carrier (ATT04) .....	17
iv. RSSI reading (ATT0A) .....	17
v. Version .....	18
Interfaces .....	19
i. Selection .....	19
ii. UART mode.....	19

iii. UART Configuration (in yellow: by default).....	20
iv. Serial buffers .....	21
v. Mode SPI .....	22
Operating mode .....	26
i. Transparent (serial/RF bridge: ARM-N8-LP/LD) .....	26
ii. Sigfox Uplink (ARM-N8-SF) .....	32
Radio part.....	34
i. Principal parameters (by default).....	34
ii. Header .....	34
iii. Radio channels .....	36
iv. Whitening.....	36
v. Listen before talk (LBT).....	37
vi. Adaptive Frequency Agility (AFA) .....	38
vii. Repeater .....	38
Sleep mode .....	39
i. Sleep/wake-up sources .....	39
ii. Entrance and exit of the sleep mode condition .....	39
<i>Wake On Radio (WOR)</i> .....	41
i. Principal.....	41
ii. WOR reception method .....	42
iii. Post-WOR treatment.....	42
iv. Wake up events (example).....	43
Signalizations.....	45
Measured current at 3,3V .....	46
Consumed current Optimization.....	47
Firmware update by bootloader .....	48
i. Versions .....	48
ii. Using the Upgrader.exe.....	48
Frequency table .....	49
AT registers table .....	61

## Document version history

Version	Date	Description	Author
1.0	17/05/2014	Creation	TD
1.4	13/05/2014	WOR mode, new frequencies table, Declaration of conformity, SPI mode, Repeater mode, Signalizations	TD
1.5	25/11/2015	Sigfox Uplink	TD
1.6	02/12/2015	Document title, post-WOR	TD
1.7	07/12/2015	UART parity correction	TD
1.8	25/11/2015	RSSI-PWM unavailable on Sigfox modems	TD
1.9	30/03/2016	Various corrections (Radio and consumption)	TD
2.0	02/06/2020	Document format and translation	MD

## Disclaimer

The information contained in this document is subject to change without warning and does not represent a commitment on the part of ATIM radiocommunications. ATIM radiocommunications provides this document 'as-is' with no warranty of any kind, express or implied, including but not limited to implied warranties of merchantability or fitness for a particular purpose. ATIM radiocommunications may make changes and/or improvements to this manual or to the product(s) or program(s) described in this manual, at any time.

## Trademarks and copyright

ATIM radiocommunications®, ACW ATIM Cloud Wireless® and ARM Advanced Radio Modem® are registered trademarks of ATIM SARL in France. The other trademarks mentioned in this document are the property of their respective owners.

## Declaration of compliance

All ARM Advanced Radio Modems® products comply with the regulatory requirements of the R&TTE Directive (1999/5/EC), article 3:



**1 SAFETY** (Article 3.1a of the 1999/5/EC Directive)

EN62311:2008 **Human Exposure Restrictions for Electromagnetic Fields**

EN61000-6-2: 2005 **Electromagnetic compatibility (EMC) - Immunity for industrial environments**

**2 Electromagnetic compatibility** (Article 3.1b of the 1999/5/EC Directive)

EN 301489-3 v1.4.1, EN 301489-1 V1.9.2

**3 Efficient use of the radio frequency spectrum** (Art.3.2 of the 1999/5/EC Directive)

ETSI EN300 220-2 v2.4.1 and EN300 220-1 v2.4.1

**Receiver class: 2**

It is under the responsibility of the user to ensure that the configuration and the usage of the ARM-N8-LDLP fills in all the conditions 70-03 of the REC (describing the annex 1, the radio bands, g, G1, G2, G3 or G4).

## Environmental recommendations

### Environment

Respect the temperature ranges for storage and operation of all products. Failing to respect these guidelines could disrupt device operation or damage the equipment.

Follow the instructions and warnings provided below to ensure your own safety and that of the environment and to protect your device from any potential damage.



**General hazard** – Failure to follow the instructions presents a risk of equipment damage.



**Electrical hazard** – Failure to follow the instructions presents a risk of electrocution and physical injury.



Direct-current symbol



**WARNING:** do not install this equipment near any source of heat or any source of humidity.



**WARNING:** for your safety, it is essential that this equipment be switched off and disconnected from mains power before carrying out any technical operation on it.



**WARNING:** the safe operation of this product is ensured only when it is operated in accordance with its intended use. Maintenance may only be performed by qualified personnel.



Waste disposal by users in private households within the European Union. This symbol appears on a product or its packaging to indicate that the product may not be discarded with another household waste. Rather, it is your responsibility to dispose of this product by bringing it to a designated collection point for the recycling of electrical and electronic devices. Collection and recycling waste separately at the time you dispose of it helps to conserve natural resources and ensure a recycling process that respects human health and the environment. For more information on the recycling centre closest to your home, contact your closest local government office, your local waste management service or the business from which you purchased the product.

## Radio

Modems in the ARM line are radio-communication modems that use the ISM (industrial, scientific, and medical) bands, which may be used freely (at no cost and with no authorisation required) for industrial, scientific and medical applications.

# Radio regulations

## i. Context

The modems from the ARM and ACW range are part of the radio communication that use the ISM (Industry Scientific Medical) band that can be used freely (free and without authorization) for industrial, scientific, and medical applications.

A regulation has been put in place at a national and worldwide standard to control interferences and saturation of the radio bands. For the national, the regulation is insured by the ANFR (National frequencies Agency) and the ART (Regulation Authority of Telecommunications). The ANFR was created in 1996, they elaborated and edited the national distribution of the radio bands based on the radio regulation made as part of the UIT.

Concerning the civil applications, the conditions are fixed by the ART who decides the frequencies with a planning. This planning is done by cutting in regions which is also cut in different bands. Then every radio communication service is defined and a list of operators. A distinction by category is done, we can find the ministries (Defense, Research, Interior), the ART and the CSA.

## ii. Information about the regulation and the conformity

Utilization of radio frequencies is limited by national regulations. Radio modules are conceived to follow the R&TTE (Radio & Telecommunications Terminal Equipment) directive 1999/5 / CE from European Union and can be freely used in European Union. Nevertheless, restrictions regarding RF power or duty cycle can be applied.

The ARM-N8-LD/LP is a radio module conceived to be integrated in another product, often final products. According to the R&TTE directive, the final product producer is responsible of the conformity declaration for this product. The ARM-N8xx module conformity declaration is available on demand at ATIM, however, it does not cover the product where it is integrated in.

Regulation requirements can change, ATIM does not take responsibility of the exactitude and precision.

Legislation and national regulations, just as their interpretation can vary accordingly to the country. In case of uncertainty, it is recommended to contact ATIM or to consult local authorities in the concerned country.

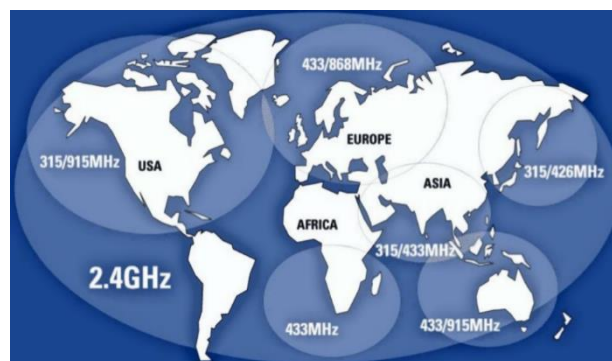

Figure 1 : ISM bandwidths use around the world

Frequency Band		Power/Magnetic Field	Spectrum access and mitigation requirements	Modulation/ maximum occupied bandwidth	ECC/ERC Decision	Notes
g1	863-870 MHz (notes 3 and 4)	25 mW e.r.p.	≤ 0.1% duty cycle or LBT (notes 1 and 5)	≤ 100 kHz for 47 or more channels (note 2)		FHSS
		25 mW e.r.p. Power density: -4.5 dBm/100kHz (note 7)	≤ 0.1% duty cycle or LBT+AFA (notes 1, 5 and 6)	No spacing		DSSS and other wideband techniques other than FHSS
		25 mW e.r.p.	≤ 0.1% duty cycle or LBT+AFA (notes 1 and 5)	≤ 100 kHz, for 1 or more channels modulation bandwidth ≤ 300 kHz (note 2)		Narrow /wide band modulation
g1.1	868-868.6 MHz (note 4)	25 mW e.r.p.	≤ 1% duty cycle or LBT+AFA (note 1)	No spacing, for 1 or more channels (note 2)		Narrow / wide band modulation. No channel spacing, however, the whole stated frequency band may be used
g1.2	868.7-869.2 MHz (note 4)	25 mW e.r.p.	≤ 0.1% duty cycle or LBT+AFA (note 1)	No spacing, for 1 or more channels (note 2)		Narrow / wide band modulation. No channel spacing, however, the whole stated frequency band may be used
g1.3	869.4-869.65 MHz	500 mW e.r.p.	≤ 10% duty cycle or LBT+AFA (note 1)	No spacing, for 1 or more channels		Narrow / wide band modulation The whole stated frequency band may be used as 1 channel for high speed data transmission
g1.4	869.7-870 MHz (note 11)	<u>5 mW e.r.p.</u> 25 mW e.r.p.	<u>No requirement</u> ≤1% duty cycle or LBT+AFA (note 1)	No spacing for 1 or more channels		Narrow / wide band modulation. No channel spacing, however, the whole stated frequency band may be used

Tableau 1: frequencies' bandwidths applicable to the 868 MHz bandwidth for "Nonspecific to short range devices" specified in the ERC 70-03, [2].



# Generalities

## i. Presentation

In order to answer more accurately to various user challenges, ATIM started a new device family called Nano-Modules composed of different modules using state of the art technologies like Ultra Narrow Band (UNB), Narrow Band (NB) and Chirp Spread Spectrum (CSS). This family has been developed for users requiring high communication range.

In fact, all the ARM-N8Lx devices have a range further than 22 km considering sight, the ARM-N8LORA exceeds 25 km and the ARM-N1LD (169Mhz) goes over 40 km. Some modules can also benefit an extended range with the repeater functionality.

ARM-N8LP/LD have double functionality; they can be used in local mode (P2P) (ISM network) and/or in SIGFOX networks (SIGFOX™ network). ARM-N8LORA can also be used in two mode, point to point LoRa communication or FSK local mode (P2P).

Every module is optimized to get the lowest power consumption possible, allowing users to develop battery powered devices. With the right batteries and configuration, a module can be used up to 10 years without changing batteries. Every module is pin to pin compatible, allowing users to get different communication possibilities without having to redesign their hardware.

## ii. ARM range and ACW range

Since 2014, the ARM product range has been replaced by the ACW range. The ARM-Nano radio modules managed the transition between the two ranges insuring the radio compatibility.

The AT commands of the old modules ARM-U8 or ARM-C8 are not compatible with the ARM-Nano (The AT commands addresses stay compatible).

The Nano product range is available in N8: 868MHz:

- **N8-LP: Low Power module (P=14dBm)**
- **N8-LD: Long distance module (P= 27dBm)**

## iii. Soldering & Environment



Before implementing of soldering the ARM-N8 module, it needs to be totally disconnected from the power supply. It is forbidden to change components while the power supply is still connected.



This would damage the equipment. Keep away from any humidity, do not pour any liquid on the module. The Arm radio module is supposed to be used inside and at an altitude less than 2000 meters.

## Technical features

### i. Electrical and mechanical characteristics

<b>Dimensions</b>	30 x 18 x 2,5 mm (25 pins)
<b>Radio Regulation</b>	EN 300 220 V2.4.1
<b>Operating Temp</b>	-20°C to +70°C
<b>Modulation</b>	2GFSK/4GFSK
<b>Sensitivity</b>	-122dBm @1,2kbps BER10-3
<b>Range</b>	>20 km (FEL)
<b>Frequency</b>	863 – 870 MHz
<b>Output power max</b>	500 mW (27 dBm)
<b>Data rate</b>	100 bit/s to 115,2 Kbit/s
<b>Radio consumption (Tx)</b>	500 mA (27dBm)
<b>Sleep consumption</b>	1µA (ARM N8LP), 2.5 µA (ARM N8LD)
<b>Radio consumption (Rx)</b>	26 mA
<b>Interface (max)</b>	UART (0,2MHz)/SPI (1,3MHz)
<b>Setup</b>	AT cmds / SPI cmds / Modbus registers
<b>Features</b>	LBT, AFA, FastUARTwakeUp, WakeOnRadio, Repeater
<b>SMD Mounting</b>	

### ii. Dimensions

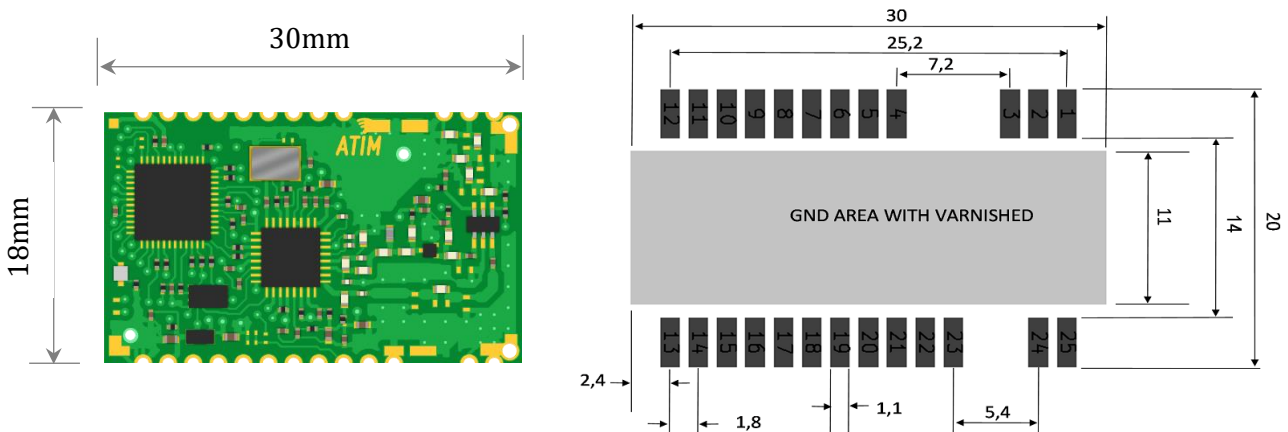

For the ARM-Nx-LD or Nx-LP, the dimensions are similar.

### iii. Pins

PIN	NAME	I/O	FUNCTION
1	AGND	-	GROUND
2	ANTENNA	-	RF SIGNAL
3	AGND	-	GROUND
4	AGND	-	GROUND
5	OSC1	I	QUARTZ INPUT
6	OSCO	I	QUARTZ INPUT
7	MOSI	I	PORT SPI SLAVE DATA IN
8	!SS	I	PORT SPI SLAVE CHIP SELECT
9	MISO	O	PORT SPI SLAVE DATA OUT
10	SCLK	I	PORT SPI SLAVE CLOCK
11	SMSG	O	OUTPUT MESSAGE RADIO PENDING
12	DGND	-	GROUND
13	DGND	-	GROUND
14	VDD	-	POWER SUPPLY
15	INT0	I	INPUT INTERRUPTIBLE / WAKE UP
16	U1CTS	I	CLEAR TO SEND UART
17	U1RTS	O	REQ. TO SEND UART
18	U1RX	I	RX UART
19	U1TX	O	TX UART
20	RSSI	O	ANALOG OUTPUT or DIGITAL
21	AN0	I	ANALOG INPUT
22	RESET	I	INPUT RESET MCU
23	AGND	-	GROUND
24	AGND	-	GROUND
25	AGND	-	GROUND

### iv. Consumption features

		Min.	Typ.	Max.
Power supply (Vdd)		3V	3,3V	3,6V
Consumption at 3,3V	Tx / 25mW	-	50mA	60mA
	Tx / 500 mW (LD version)	-	700mA	900mA
	Rx	-	31mA	45mA
	Sleep	0,7µA	1µA	2,5µA
Input voltage		GND	-	0,2 x VDD
Output voltage		0,8 x VDD	-	VDD

## v. Link interfaces

- UART 2 wires + flow control by RTS/CTS (1200 – 230400 bps)
- SPI Slave ( $\leq 2$ MHz)
- 1 wake up input
- 1 digital output « signalization »
- 1 analog output 12 bits (option)
- functioning mode:
  - ✓ Transparent mode « UART/RF bridge » or « SPI/RF bridge »
  - ✓ Slave Modbus mode
  - ✓ Master Modbus mode (specifications are required)
  - ✓ Repeater mode
  - ✓ Configuration mode « AT » local and distant
  - ✓ Test modes: Ping-pong, pure carrier, continuous request, RSSI reading

## vi. Firmware update

The software embedded on ARM-N8-LD/LP modules can be updated via the software ds30Loader (compatible with Windows/Mac/Linux) via UART. The file is available on demand.

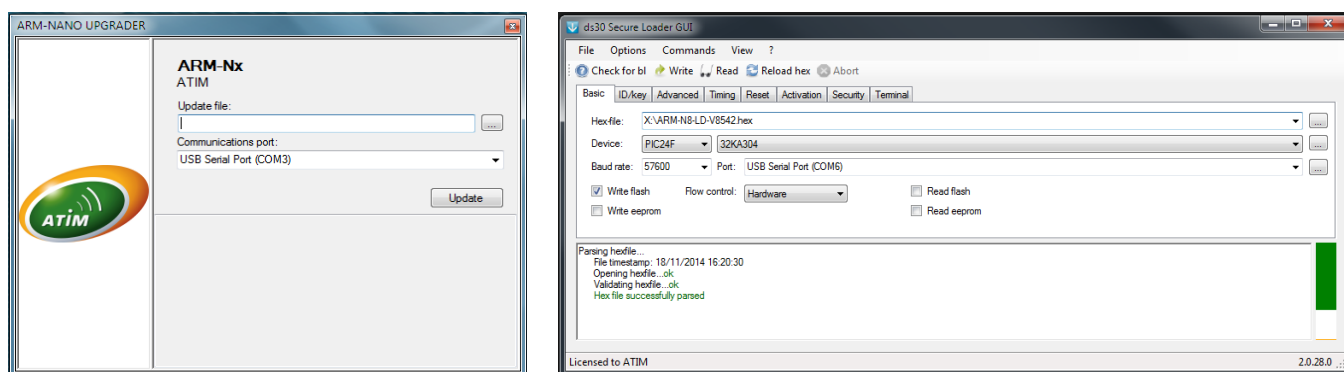

Figure 2 : Software for the firware's update

## vii. RF features

N8: 863 – 870MHz: 553 available channels (in short bandwidth)

The ARM-N8 modules are usually, set on the channel 869.525MHz (channel 522 / 0x020A) speed of 1200bps.

The range is done at 3m from the ground  $\frac{1}{2}$  wave antennas.

Mode	Data rate (bps)	Number of modules symbols (GFSK)	Narrow band	Rejection adjacent channel (N-1/N+1)	Rejection alternance channel (N-2/N+2)	Blocking at +/-1 MHz, +/-2 MHz, +/- 10 MHz	Sensibility in dBm (BER @10-3)	Channels at 14dBm / 25mW		Channels at 27dBm/500mW	
								Number of channels	Range measured at 3m from the ground [FE]	Number of channels	Range measured at 3m from the ground [FE]
	1200	2	YES	-48dBc	-48dBc	-48dBc	-123	553		19	20km
	2400	2	YES	-46dBc	-46dBc	-46dBc	-122	553		19	
	4800	4	YES	-43dBc	-43dBc	-43dBc	-119	553		19	
	9600	4	NO	-45dBc	-46dBc	-46dBc	-118	273		9	18km
	19200	4	NO	-41dBc	-41dBc	-42dBc	-116	180		5	
	38400	4	NO	-40dBc	-32dBc	-42dBc	-113	137		7	
	57600	4	NO	-40dBc	-30dBc	-46dBc	-112	88		3	
	115200	4	NO	-37dBc	-42dBc	-50dBc	-106	33		1	
COMPATIBLE	9600	2	NO					3		3	
	19200	2	NO					3		3	
	38400	2	NO					3		1	

## viii. Delay

		Delay
Launch	slow (with bootloader)	3s
	fast (without bootloader)	20ms
Buffer of the UART characters		2 $\mu$ s
Emission characters UART >> RF	Packaging mode	3 x bytes after the last UART character received
	Endless mode	immediate after the last UART character received
Reception characters RF >> UART	Packaging mode	immediate after the last RF byte received
	Endless mode	Immediate after receiving the preamble
Radio turnaround time	(Tx-Rx or Rx-Tx)	30 $\mu$ s
Configuration Input	(AT commands)	Immediate after receiving '+++'
Configuration output	(AT commands)	120ms after receiving 'ATQ'
Sleep mode input	'0' on pin INTO	10ms after end of radio activity
Sleep mode output	'1' on pin INTO	10ms

ix. Memory

Function	Memory type	Placing	Capacity (bytes)
Bootloader + Firmware + Serial number	Flash	MCU	32k
AT commands backup	EEPROM	MCU	512
Buffer serial Rx	RAM	MCU	512
Buffer serial Tx	RAM	MCU	256
Buffer Radio Rx	RAM	MCU	128
Buffer Radio Tx	RAM	MCU	128
Special Backup (on demand)	Flash	External	2M

## Hardware integration

### i. Power supply

The module power supply is between 2,7V and 3,6V. To guaranty a correct filter for the supply the filter LC Figure 3 must be put into place the closest to the pin VDD.

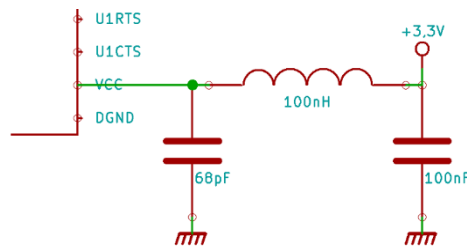

Figure 3 : power supply filter

### ii. Impedance of the antenna adaption

The passive components to integrate between the antenna and the RF pin of the ARM-N8 module depends on the length of the electronic track, of the dielectric and the antenna that is chosen. For a rapid implementation, a serial condenser of 68pF can be used. The other components are optional and do not need to be wired.

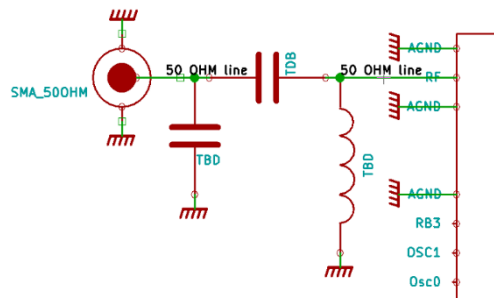

Figure 4 : impedance adaptation

### iii. Print and ground plan

It is recommended to cover the whole surface under the ARM-N8 module with a ground plan. This surface must be varnished to avoid any short. It is advised not to put vias on this surface.

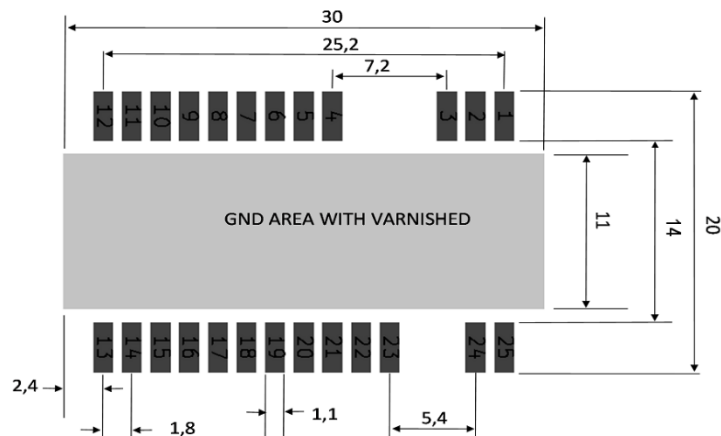

Figure 5 : Ground plan footprint

## AT command configuration

The UART link is at 19200bps as standard, 8 bytes data, no parity, 1 stop byte, Without flow control.

To go into AT command mode who must:

- Send three consecutives '+' characters: Manual mode with 3 individuals '+' via terminal. In transparent mode, this method will send at the same time two '+' by radio.
- Send three '+' characters: Packaged 3 '+' characters. In transparent mode, this method does not send three '+' by radio.

The memorization of the parameters is instantaneous and applied after a reset, ON/OFF, ATR, ATQ. For a running configuration (without EEPROM writing), it is recommended to use the ATH commands then ATI for a reboot with the new parameters.

Command	Function
+++	AT command enter
ATQ + ENTER	AT command exit
ATR + ENTER	MCU Reset
ATI + ENTER	MCU Reboot
ATS'XXX' + ENTER	Reading EEPROM of the register SXXX. XXX decimal value
ATS'XXX'='YY' + ENTER	Writing EEPROM of the register SXXX. XXX decimal value, YY hexadecimal value
ATH'XXX' + ENTER	Reading RAM of the register HXXX. XXX decimal value
ATH'XXX'='YY' + ENTER	Writing RAM of the register HXXX. XXX decimal value, YY hexadecimal value
ATF + ENTER	Reset in factory mode
ATV + ENTER	Modem version
ATL + ENTER	ATS registers list

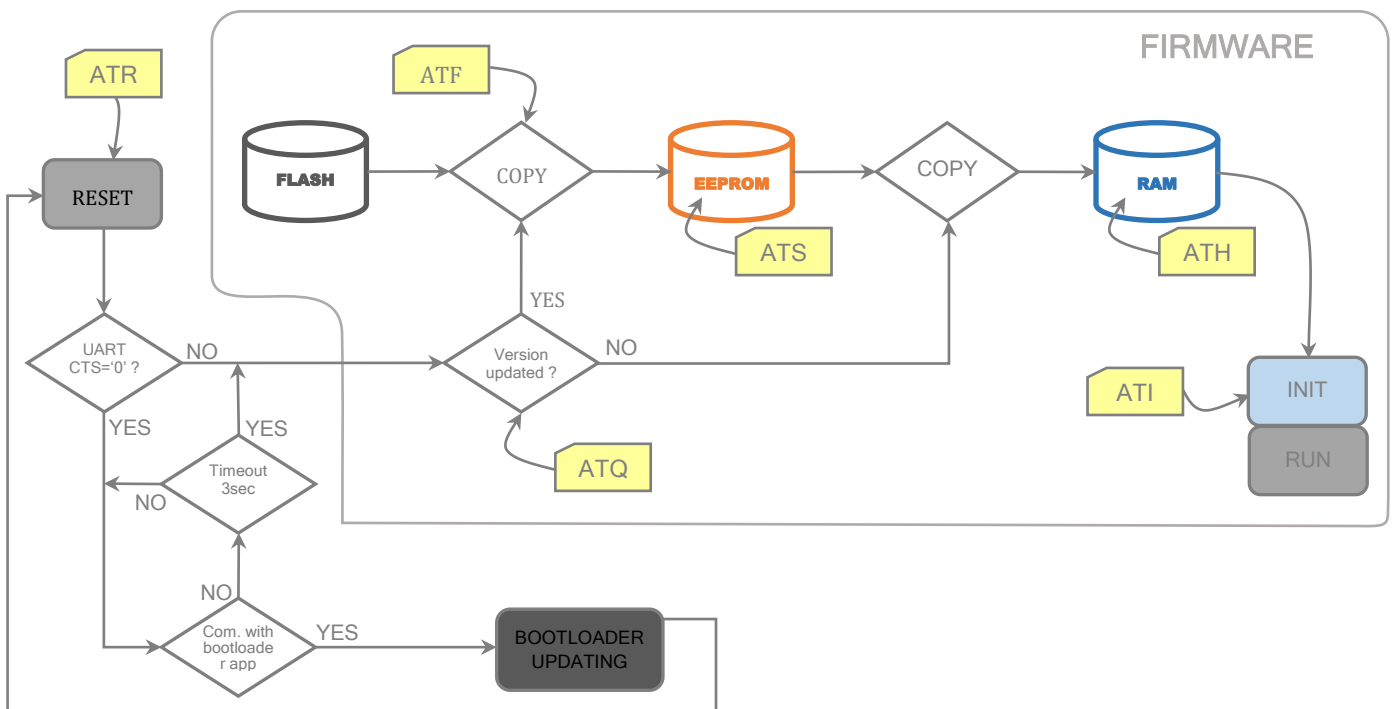



## Test modes

Cmd	Function
+++	AT command enter
ATT'ZZ' + ENTER	<p><u>Testing mode 'ZZ' :</u></p> <p>ZZ = 00 : Ping-Pong Master            ZZ = 01 : Ping-Pong Slave            ZZ = 02 : Continuous reception            ZZ = 03 : BER result            ZZ = 04 : Emission pure carrier            ZZ = 05 : NC            ZZ = 06 : NC            ZZ = 07 : NC            ZZ = 08 : NC            ZZ = 09 : NC            ZZ = 0A : RSSI value on current channel            ZZ = 0B : sleep mode enter (exit by sending characters)            ZZ = 0C : NC            ZZ = 0D : Reset BER result</p> <p><u>Keyboard commands:</u></p> <p>'a' : <b>exit current test mode</b>            'z' : increase radio emission power            's' : reduce radio emission power            'q' : reduce the frequency from one channel            'd' : increase the frequency from one channel            'x' : lowers the period (ping-pong mode , reading rssi)            'c' : increase the period (ping-pong mode , reading rssi)            'e' : deducts the destination number            'r' : increases the destination number            't' : activates/deactivates the repeater</p> 

### i. Ping-pong mode (ATT00 and ATT01)

Every active module act like a slave ping-pong and is ready to answer to master ping-pong requests without the user needing to manually go into ping-pong slave mode. The power can be reduced or increased with 'z' or 's', the frequency with 'q' or 'd'. The radio protocol addresses can be increased or deducted with 'e' or 'r'.

### ii. Continuous reception mode (ATT02)

This mode allows to the receive the frames sent by a distant modem and to put an RSSI statue message and the end of the frame. Display BER / PER (ATT03) results

A link budget is described with many characters by different criteria with an error rate of the exchanged packets and the number of totals of wrong bytes. These meters can be erased with the command ATT0D.

### iii. Pure carrier (ATT04)

A pure carrier with an undefined time can be configured to appreciate the output power, the current consumed in Tx, or in the case of antenna alignment, the orientation of this one compared to a distant modem in RSSI reading mode. The power can be reduced or increased with 'z' or 's', the frequency with 'q' or 'd'. This command must be temporary and not disturb another system.

### iv. RSSI reading (ATT0A)

This mode sends the actual RSSI averaged on a time interval that can be reduced or increased with 'x' or 'c'. The frequency can be reduced or increased with 'q' or 'd'.

```
RealTerm: Serial Capture Program 2.0.0.70
ATT00
Entering in ping-pong mode
> Frame:0001 Local 0:00 Remote 0:FF Channel:0200 Pout:14dBm
> Frame:0001 OK 1191ms RSSI:-56dBm/-69dBm PER:0000/0001 BER:0000/0050
> Frame:0002 Local 0:00 Remote 0:FF Channel:0200 Pout:14dBm
> Frame:0002 OK 1187ms RSSI:-56dBm/-69dBm PER:0000/0002 BER:0000/0000
> Frame:0003 Local 0:00 Remote 0:FF Channel:0200 Pout:14dBm
> Frame:0003 OK 1186ms RSSI:-56dBm/-69dBm PER:0000/0003 BER:0000/0100
> Frame:0004 Local 0:00 Remote 0:FF Channel:0200 Pout:14dBm
> Frame:0004 OK 1186ms RSSI:-56dBm/-69dBm PER:0000/0004 BER:0000/0160
> Frame:0005 Local 0:00 Remote 0:FF Channel:0200 Pout:14dBm
> Frame:0005 OK 1187ms RSSI:-56dBm/-69dBm PER:0000/0005 BER:0000/0100
> Frame:0006 Local 0:00 Remote 0:FF Channel:0200 Pout:14dBm
> Frame:0006 OK 1187ms RSSI:-56dBm/-69dBm PER:0000/0006 BER:0000/0210
> Frame:0007 Local 0:00 Remote 0:FF Channel:0200 Pout:14dBm
> Frame:0007 lost PER:0001/0007 BER:0000/0210
Test mode stopped
ATT04
Pure Carrier Channel:0200 Pout:14dBm
Test mode stopped
ATT00
Entering in spectrum-analyser mode RSSI Mean/Max
Channel:0200 RSSI:-116dBm/-109dBm
Channel:0200 RSSI:-115dBm/-107dBm
Channel:0200 RSSI:-115dBm/-107dBm
Test mode stopped
```

Figure 6 : Terminal in test mode

#### v. Version

From the command mode, it is possible to get these information's via the command « ATV »:

- Firmware version
- Card version
- Sigfox ID (if ARM-N8-Sigfox version)

# Interfaces

## i. Selection

The SPI slave is automatically activated at the expense of the UART interface if pin !SS/SCS is at digital state 1 (3,3V) at the initialization (at startup or after quitting the command mode) of the modem.

## ii. UART mode

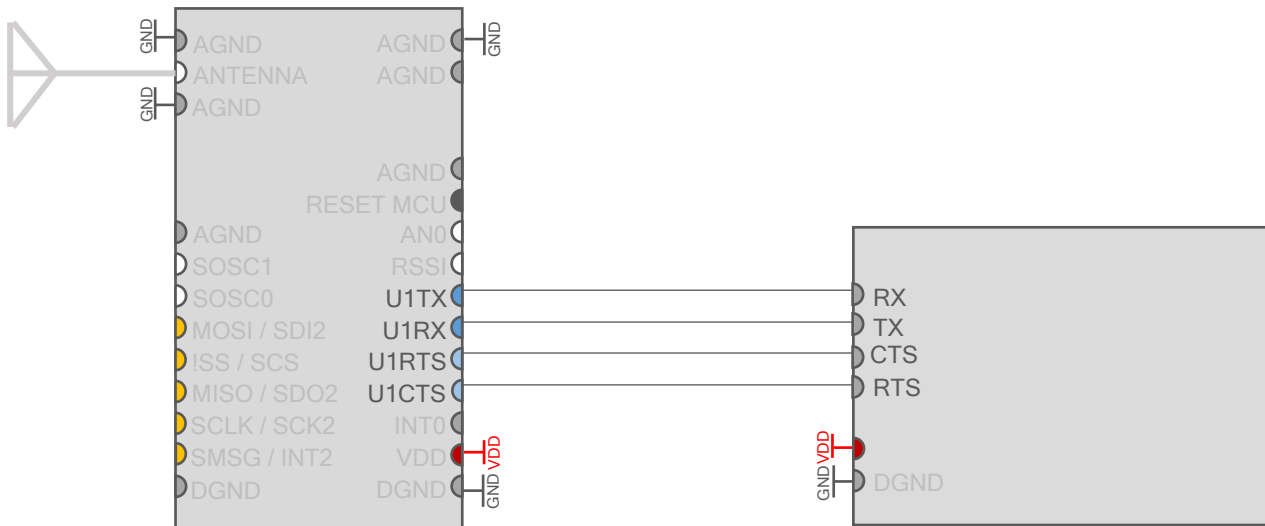

The RTS and CTS signals are optional. A software flow control is done because of the management of the frames in the serial reception (see **¡Error! No se encuentra el origen de la referencia.** page **¡Error! Marcador no definido.**).

For 7 bytes of data (ATS013=07), the parity must be activated (ATS014=01 or 03).

iii. UART Configuration (in yellow: by default)

Baudrate UART

ATS	bit	Parameters	value register
012	0:7	UART Baudrate	1200bps=0x00,
			2400bps=0x01,
			4800bps=0x02,
			9600bps=0x03,
			19200bps=0x04,
			38400bps=0x05,
			57600bps=0x06,
			115200bps=0x07,
230400bps=0x08,			

Data bytes

ATS	bit	Parameters	value register
013	0:7	UART Data bytes	7 bits = 0x07
			8 bits = 0x08
			9 bits = 0x09

ATS	bit	Parameters	value register
014	0	Parity	None= 0x00, 0x02 Impair = 0x01 Pair = 0x03
	1		
	2		
	3		
	4		
	5		
	6		
	7		

Stop bytes

ATS	bit	Parameters	value register
015	0:7	UART Stop bytes	1 bit = 0x01
			2 bits = 0x02

UART flow control

ATS	bit	Parameters	value register
016	0:7	UART control flow	None=0x00
			RTS/CTS=0x01

#### iv. Serial buffers

The ARM-N8 module has two independent buffers:

- circular reception buffer of 512 bytes
- circular emission buffer of 256 bytes

The reception buffer can memorize the beginning and the end of every finished frame at a dead time ( $T_f$ ) of 3 x byte time at the UART speed.

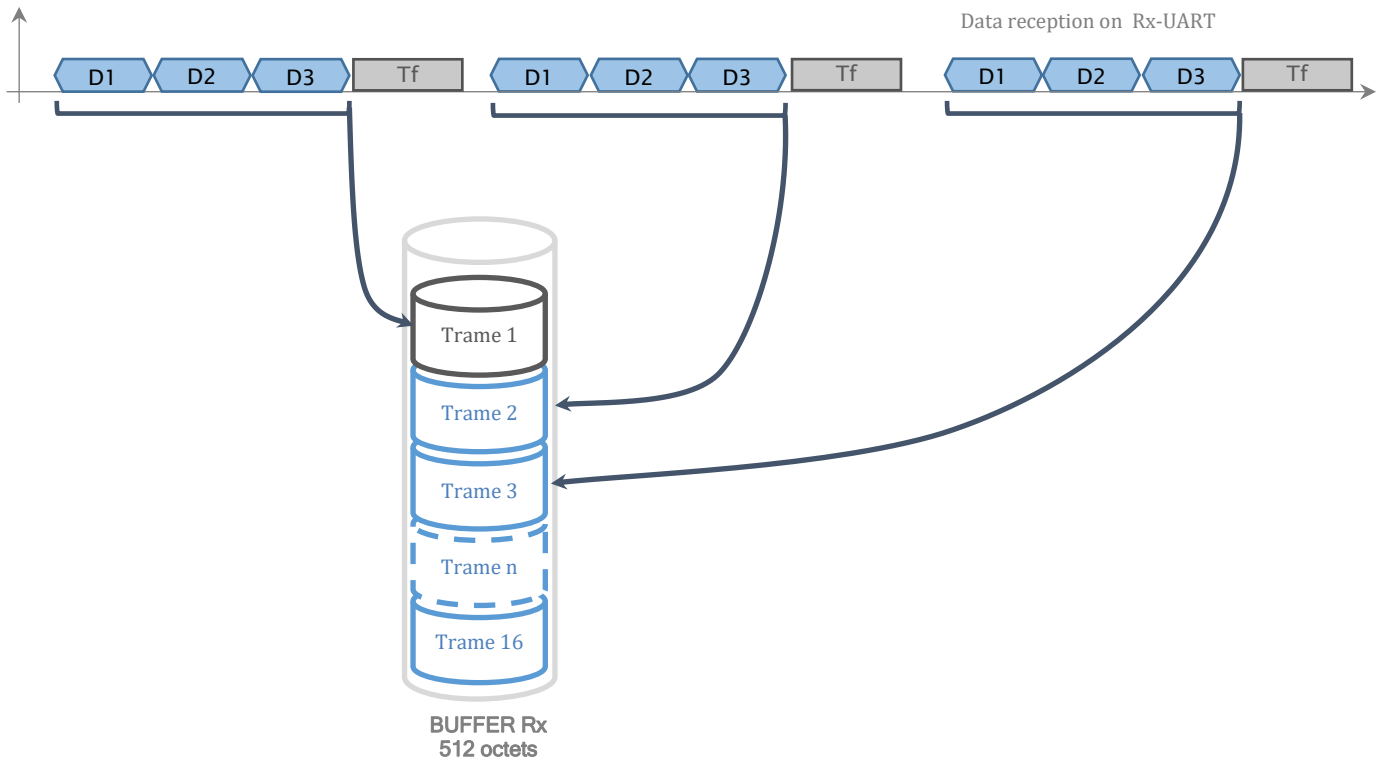

This mechanism enables to reproduce the flow on the distant modem by successive radio emissions. It is not done in an endless data transmission for each character received is immediately shaped to be sent by radio.

To activate this mechanism, the byte 1 of the register ATS020 must be at 1.

Serial packetized Mode / RF

ATS	bit	Parameters	value register
020	0	_AllTraffic	0x07
	1	_TxRF_PacketMode	
	2	_RxRF_PacketMode	
	3	_NC	
	4	_NC	
	5	_NC	
	6	_NC	
	7	_NC	

v. Mode SPI

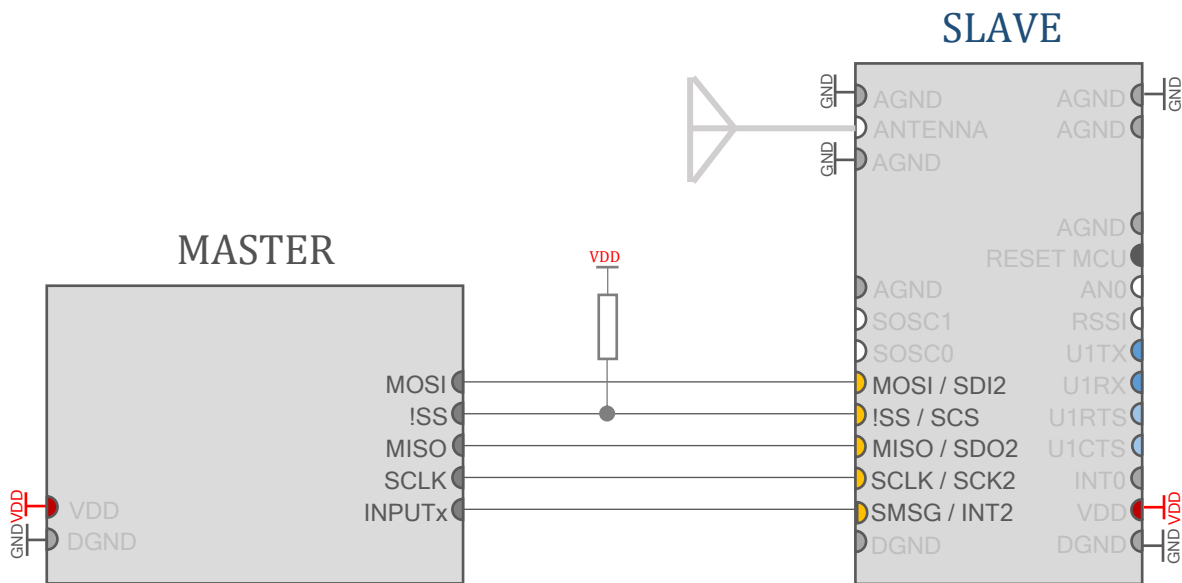

a. Master configuration

	Min.	Typ.	Max.
SCLK clock frequency	-	1MHz	1,33MHz

(Clock polarity / CPOL / CKP):

- Rest at low level ('0' : GND) ; active at high level ('1' : VDD)

(Clock edge / CKE / NCPHA):

- Data transmission when the clock goes from active to rest (1⇒0)

Delays:

- The ARM-NANO reads sequentially, byte by byte, the information of the SPI frame. It is recommended to observe a delay of 2µs between each byte.
- To finalize the information exchange by SPI, it is recommended to keep a delay of around 1 ms between two SPI operations (1ms between rising edge !SS and falling edge !SS).

## b. Serial Buffers

The ARM-N8 module has two independent buffers:

- circular reception buffer of 512 bytes
- circular emission buffer of 256 bytes

The reception buffer is capable of memorizing the start and the finish of every finalized frame at the end of the data transfer on the SPI bus (rising edge !SS).

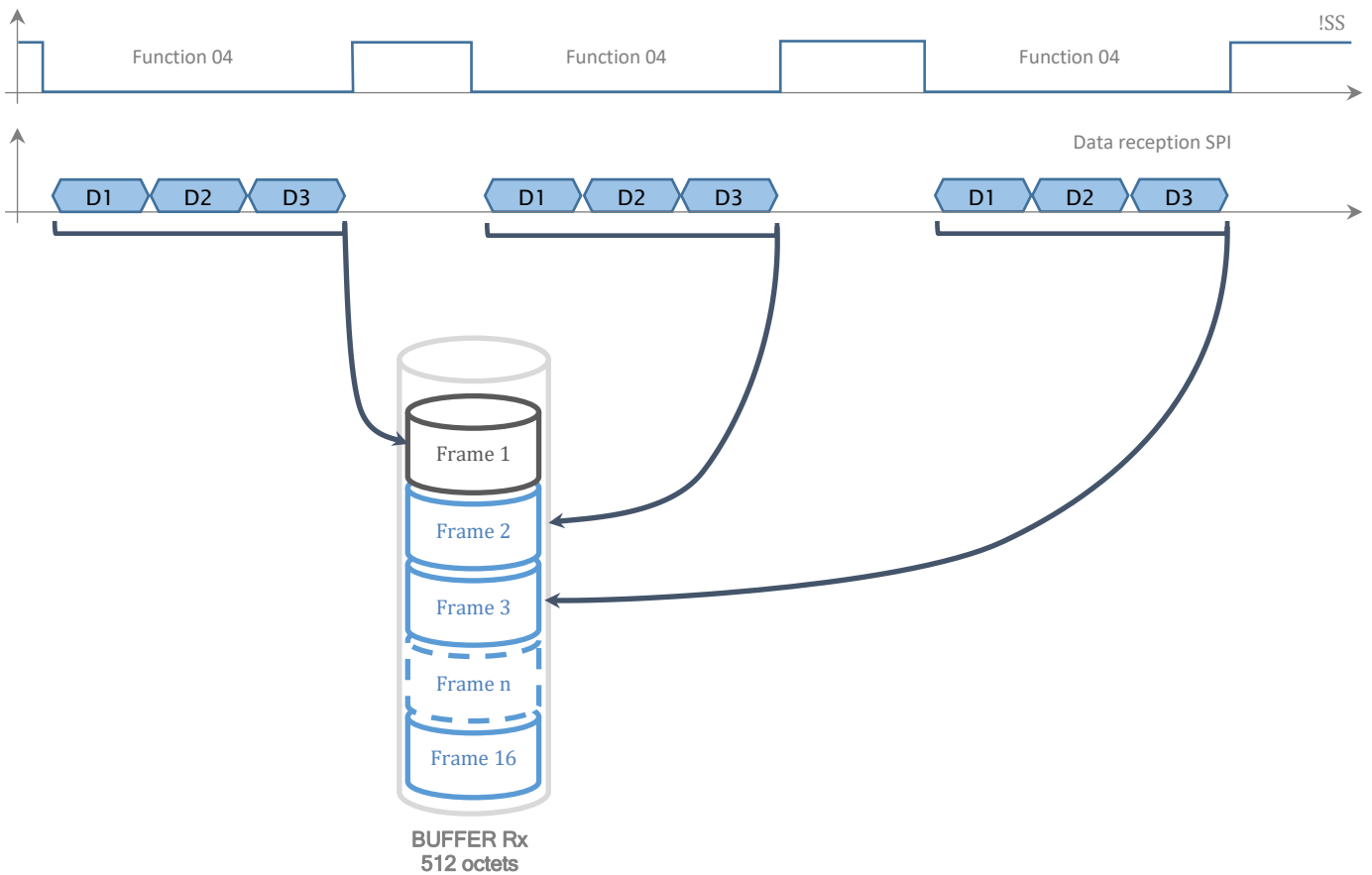

### c. Functions

Function	Function code	Address	Data			
	H0	H1	D0	D1	Dn-1	Dn
read register AT	0x01	0x00 - 0xFF	0x00	Return content register @H1	Return content register @H1+(n-1)	Return content register @H1+(n)
write register AT	0x02	0x00 - 0xFF	write D0 in register @H1	write D1 in register @H1+1	write Dn-1 in register @H1+(n-1)	write Dn in register @H1+(n)
Get octet radio	0x03	0x00	0x00	Return content FIFO Rx index 1	Return content FIFO Rx index n-1	Return content FIFO Rx index n
Get octet radio	0x04	0x00	write content FIFO Tx index 0	write content FIFO Tx index 1	write content FIFO Tx index n-1	write content FIFO Tx index n
Get RSSI	0x05	0x00	0x00	Current RSSI	Current RSSI	Current RSSI
Get current radio message length	0x06	0x00	0x00	Number of bytes in FIFO Rx content	Number of bytes in FIFO Rx content	Number of bytes in FIFO Rx content
Restart Modem	0x07	0x00	0x00	0x01	0x01	-
Reset modem	0x08	0x00	0x00	0x01	0x01	-

### d. Read AT register

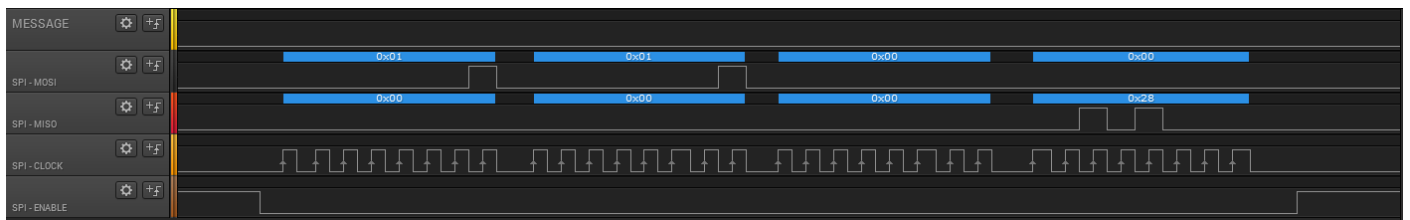

### e. Write AT register

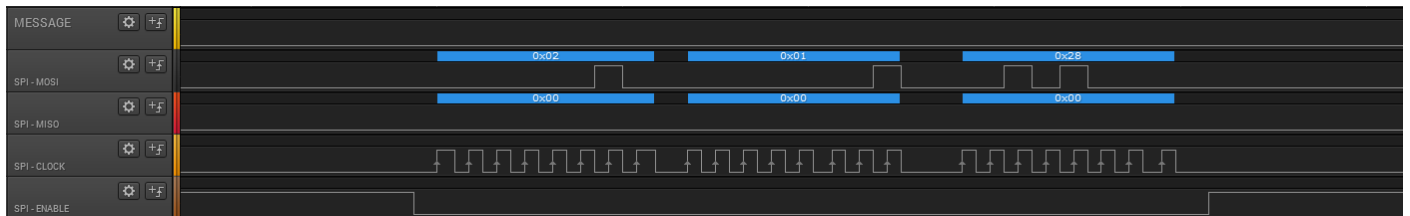



f. Get current radio message length

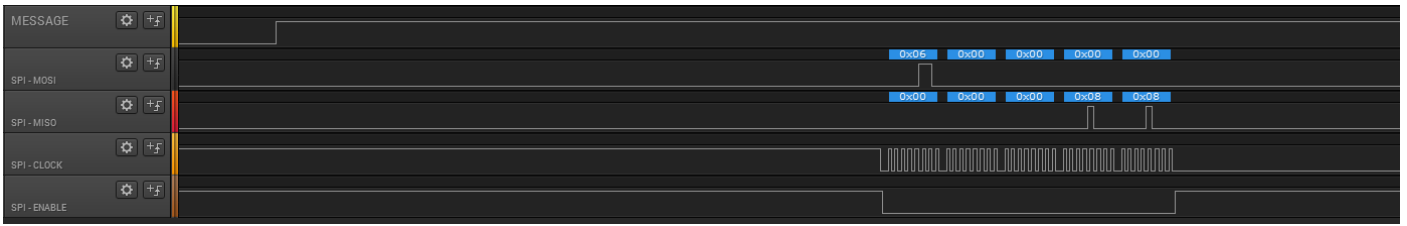

g. Get byte in the radio buffer

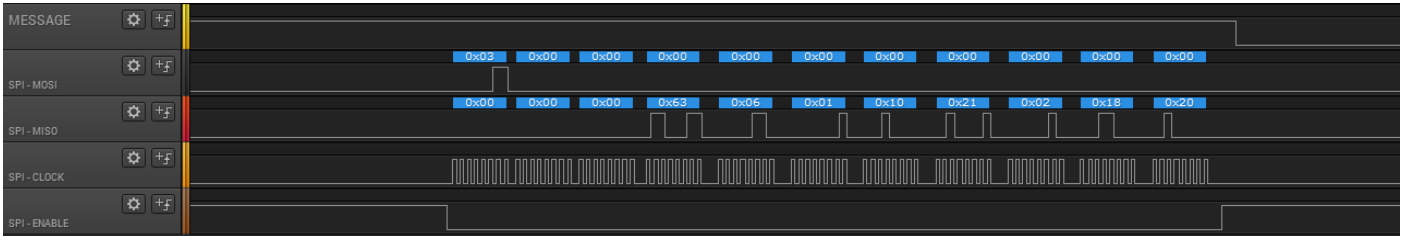

h. Provide byte in the radio buffer

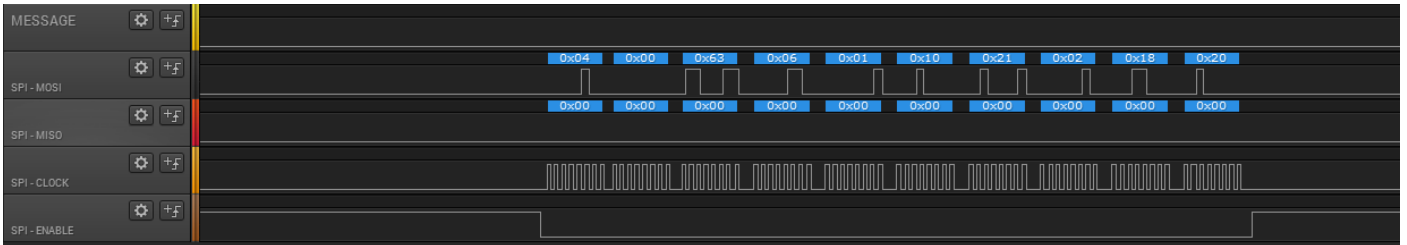

i. Restart

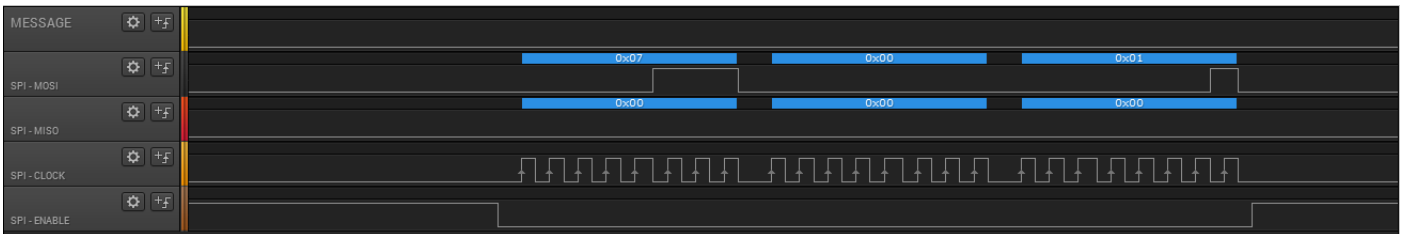

# Operating mode

## i. Transparent (serial/RF bridge: ARM-N8-LP/LD)

### a. Configuration

To activate this mode, you need to configure: `ATS000=10`

### b. Operation

In this mode, the stocked data in the serial buffer are fitted to be sent by radio. The radio transmissions are done in half duplex. Many parameters can influence the delay created by the data transfer. Usually, the shortest delays are when the data is stocked the less possible in the modems buffer.

To minimize the communication problems (on the UART particularly), the data rate must be the same for both communications (serial and radio). The nature of the data by radio, the preamble emission phase, of synchronization and the start and end control or frame errors, will affect the data transfer delays.

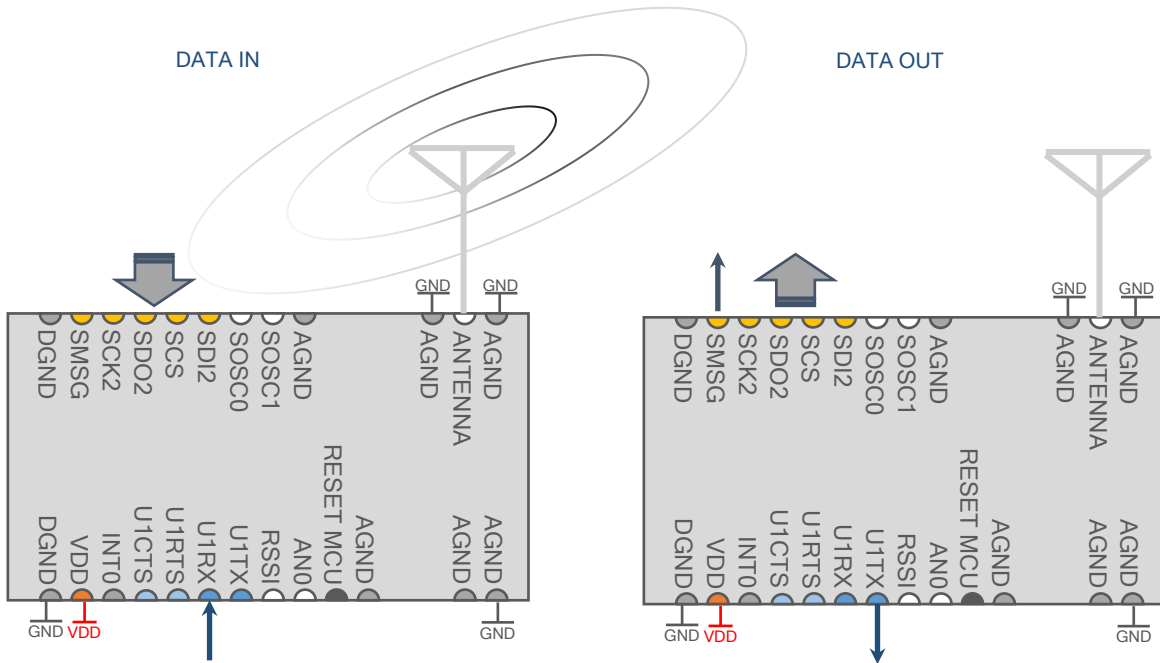

### c. Endless<sup>1</sup> Mode

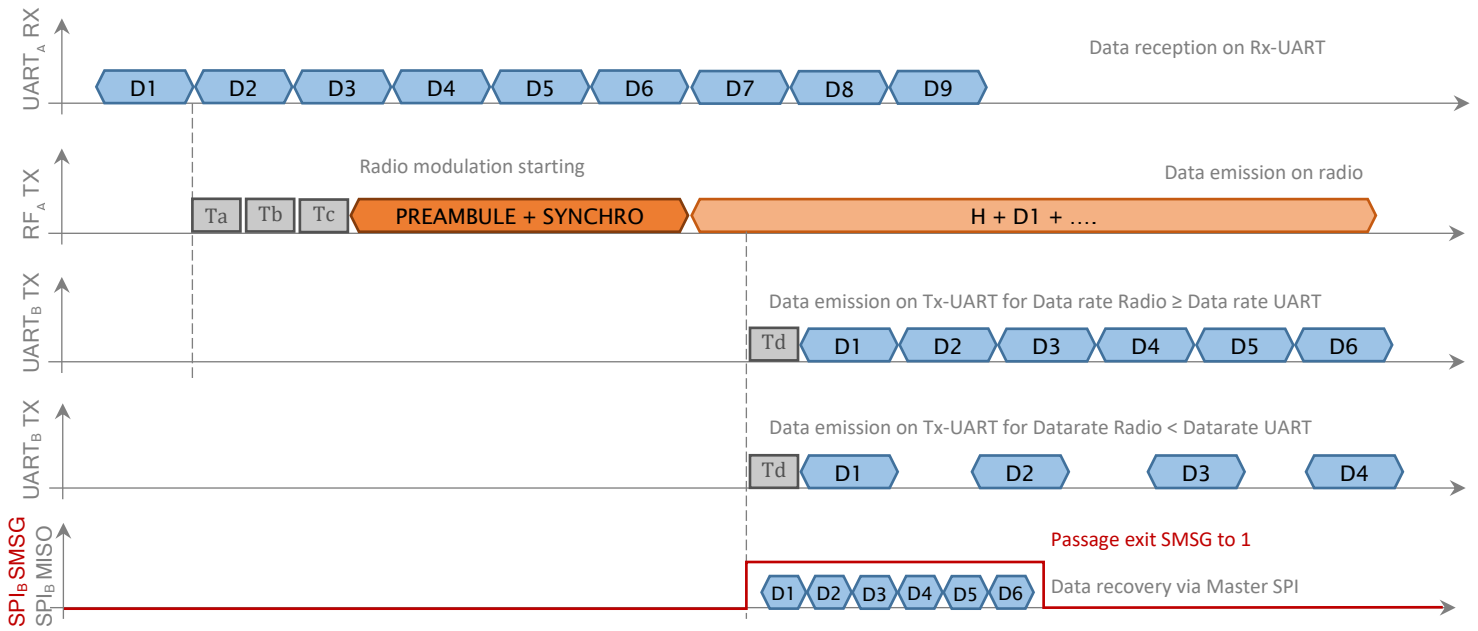

Ta: if enabled, Time 'Listen before talk' 5ms (ATS092.bit0)

Tb: if enabled and justified, Time random alias 'Listen before talk' after radio silence (ATS092.bit0)

Tc: Time before radio emission (ATS017)

Td: Time before serial emission (ATS018-019)

The packetization of the serial data can be forced by ATS020.bit1-2. The behavior you will be close to the packetized mode (see d Packetized mode page 29).

#### Advantages

- ✓ Radio emission from the first serial byte
- ✓ Serial emission from the first radio byte
- ✓ unlimited frame length
- ✓ Low latency

#### Disadvantage

- ✗ No radio CRC control
- ✗ Inter byte delay if the data rate is not the same

<sup>1</sup> The infinite mode is not compatible with the packetized or compatible mode.

## Endless mode configuration

Endless packet mode without LBT or AFA

ATS	bit	Parameters	value register
092	0	_ListenBeforeTalkEnabled	0x80
	1	_AFAEnabled	
	2	_LongPreamble	
	3	_WOR_CS	
	4	_NC	
	5	_NC	
	6	_VariablePacketLength	
	7	_InfinitePacketLength	

Packetization Mode Serial / RF

ATS	bit	Parameters	value register
020	0	_AllTraffic	0x07
	1	_TxRF_PacketMode	
	2	_RxRF_PacketMode	
	3	_NC	
	4	_NC	
	5	_NC	
	6	_NC	
	7	_NC	

Time before radio emission

ATS	bit	Parameters	value register
017	0:7	Radio_DelayBeforeTx (0 – 255ms)	0x00

Time before serial emission

ATS	bit	Parameters	value register
018	0:7	Serial_DelayBeforeTx LSB	0x00
019	0:7	Serial_DelayBeforeTx MSB	0x00

### d. Packetized mode<sup>2</sup> (Default mode)

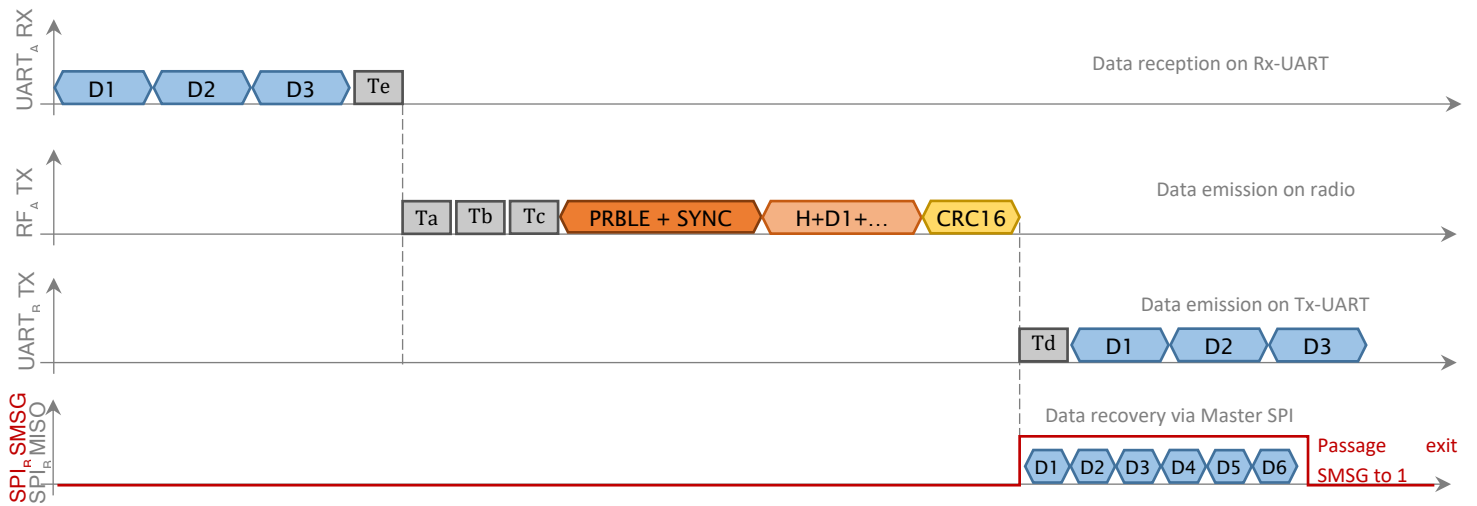

Ta: if enabled, Time 'Listen before talk' 5ms (ATS092.bit0)

Tb: if enabled and justified, Time random alias 'Listen before talk' after radio silence (ATS092.bit0)

Tc: Time before radio emission (ATS017)

Td: Time before serial emission (ATS018-019)

Te: 3 x Time serial byte delimiting a packet

CRC if enabled: delay CRC 16bits (if error: no data emission on Tx-UART)

#### Advantages

- ✓ Compatible with different UART data rates
- ✓ CRC16 frame control

#### Disadvantage

- ✗ Radio frame length of 120 bytes
- ✗ Latency

<sup>2</sup> The packet mode is not compatible with the infinite or compatible mode.

## Packet mode configuration

Packet mode without LBT or AFA

ATS	bit	Parameter	Register value
092	0	_ListenBeforeTalkEnabled	0x40
	1	_AFAEnabled	
	2	_LongPreamble	
	3	_WOR_CS	
	4	_NC	
	5	_NC	
	6	_VariablePacketLength	
	7	_InfinitePacketLength	

Serial packet mode / RF

ATS	bit	Parameter	Register value
020	0	_AllTraffic	0x07
	1	_TxRF_PacketMode	
	2	_RxRF_PacketMode	
	3	_NC	
	4	_NC	
	5	_NC	
	6	_NC	
	7	_NC	

Time before radio emission

ATS	bit	Parameter	Register value
017	0:7	Radio_DelayBeforeTx (0 – 255ms)	0x00

Time before serial emission

ATS	bit	Parameter	Register value
018	0:7	Serial_DelayBeforeTx LSB	0x00
019	0:7	Serial_DelayBeforeTx MSB	0x00

### e. Compatible<sup>3</sup> Mode

So that there is not a problem in the compatibility with the old ARM generation (without ARM-NANO), the ARM-N8 can be interfaced by radio with these registers:

The packetization of the data can be forced by configuring ATS020.

(For this mode, the WOR mode, the ping pong test mode and continuous reception are not)

#### Compatible mode configuration

Baudrate Radio

ATS	bit	Parameters	Register value
008	0:7	Baudrate Radio	COMPATIBLE: 0x09 : 38400bps 0x0A : 19200bps 0x0B : 9600bps

Radio channel (old representation)

ATS	bit	Parameters	Parameter value	Register value
002	0:7	Radio channel Tx - Rx	16 channels from 868 to 870 MHz	0 - F
003	0:7	Radio channel Tx - Rx	16 channels from 868 to 870 MHz	0 - F

Prefix code and preamble

ATS	bit	Parameters	Register value
095	0:7	Prefix	0x60 (default)

Byte mode serial / RF

ATS	bit	Parameters	Register value
020	0	_AllTraffic	0x07
	1	_TxRF_PacketMode	
	2	_RxRF_PacketMode	
	3	_NC	
	4	_NC	
	5	_NC	
	6	_NC	
	7	_NC	

Delay before radio emission (Tc)

ATS	bit	Parameters	Value	Register value
017	0:7	Radio_DelayBeforeTx	0 - 255 ms	0x00

Time before serial emission (Td)

ATS	bit	Parameters	Value	Register value
018	0:7	Serial_DelayBeforeTx LSB	0 - 65535 ms	0x00
019	0:7	Serial_DelayBeforeTx MSB	0 - 65535 ms	0x00

<sup>3</sup> The compatible mode is not compatible with the infinite or packet mode.

## ii. Sigfox Uplink (ARM-N8-SF)

The ARM-N8-Sigfox modem references (firmware review starting by **5** or **6** : See paragraph v page 18 command ATV: *REV. X819 S/N: 6220FF5C 868MHZ 14DBM*) are capable of sending messages on the Sigfox connected devices internet network.

There are many ways to send data on the Sigfox network:

- Command `AT$SF` in test mode
- Functioning mode « Serial-Bridge »
- Functioning mode « RF-Bridge »

### a. Message format

The Sigfox base stations receive the messages of 12 bytes maximum. At this fact, the modem will cut the data that is over 12 bytes into little packets.

The sender emits at 14 dBm every message three times randomly so that it the message is received by plenty of Sigfox base stations. The messages are spaced by a silence of 0,75 sec. A message of 12 bytes lasting 2,1 sec, a whole emission can last up to 8 sec.

### b. Send data by `AT$SF`

By default, the UART link is configured like this:

`19200bps / 8 data bits / 1 stop bit / No parity / None flow control / logic levels LVTTTL`

To enter the AT commands (chapter 0 page 16), you need to press `+++` consecutively without delay. The modem replies `ARM-N8 - WELCOME IN SETUP MODE` .

The review information and Sigfox Id are sent after the command `ATV`.

When in AT command mode, the sending of the message `0123456789AB` is done by:

`AT$SF=0123456789AB` and validated by « *Entrée* » (CR/LF)

### c. Pure carrier emission by `AT$CW`

To validate the RF communication of the modem, it is possible to send a pure carrier emission by :

`AT$CW=86820000,1`

Where 86820000 is the frequency in Hertz of the pure carrier, 1 activates the emission and 0 deactivates.

### d. Sending messages in « Serial-Bridge »

This functioning mode is active for `ATS000=50`. It works at the startup of the modem (outside of the AT command mode) and sends all the incoming characters of the serial buffer to Sigfox.

### e. Sending messages in « RF-Bridge »

This functioning mode is active `ATS000=60`. It works the same as the « Serial-Bridge » mode but the radio reception is active so that it can get local radio messages and resend them on the Sigfox network. The local radio configuration rules are mentioned in the chapter 0.Radio part page 34.

### f. Sending « Mixt » messages

This functioning mode is active for `ATS000=70`. The modem behaves to start in Serial-Bridge to Sigfox then it emits the same message towards a local network. The configuration rules for the local radio are mentioned in chapter 0.



g. Sending a life frame

A life frame containing « VddIdle VddTx 0x64 » can be sent periodically by configuring the register ATS045 like this:

Life frame emission period

ATS	bit	Parameters	Register value
045	0:7	0x04 : 10 minutes 0x05 : 1 hour 0x06 : 24 hours 0x07 : 7 days 0x08 : 1 month	0x00

## Radio part

### i. Principal parameters (by default)

Baudrate Radio

ATS	bit	Parameters	Register value
008	0:7	Baudrate radio	1200bps=0x01, 2400bps=0x02, 4800bps=0x03, 9600bps=0x04, 19200bps=0x05, 38400bps=0x06, 57600bps=0x07, 115200bps=0x08, (COMP) 38400bps=0x09, (COMP) 19200bps=0x0A, (COMP) 9600bps=0x0B,

Principal radio channel

ATS	bit	Parameters	value	Register value
002	0:7	Radio channel Tx - Rx LSB	560 channels 863 to 870 MHz	0A
003	0:7	Radio channel Tx - Rx MSB		02

Staged output radio power

ATS	bit	Parameters	Register value
004	0:7	Pout radio	TBD = 0xFF (S062) REGUL = 0x00 0dBm = 0x01 5dBm = 0x02 7dBm = 0x03 10dBm = 0x04 12dBm = 0x05 14dBm = 0x06 20dBm=0x07 23dBm=0x08 27dBm=0x09

Explicit output radio power

ATS	bit	Parameters	Register value
061	0:7	Pout radio (signed byte) de -18dBm à +27dBm	0x00

### ii. Header



The shape of the data in radio includes these parts:

Header long or short (ATS093.bit 7 : long = 1, short = 0)

- Payload (maxi size of 120 bytes in a packetized mode)
- Footer (CRC16 in option) (ATS093.bit 6, CRC = 1, No CRC = 0)

The header choice for a long or short enable to privilege either the routing of the radio messages, or the transmission delays.

## Addresses

In the Header long mode (bit 7, ATS093), the radio protocol inserts the expeditor and destination addresses in the header so that the radio frames are addressed. These data's enables the distant modems (in long header mode) to filter the messages or not.

Parameters radio 2

ATS	bit	Parameters	Register value
093	0	_RxToleranceLow	0xC0
	1	_PADisabled	
	2		
	3	_CC_CCA	
	4		
	5	_Whitening	
	6	_AttachCRC	
	7	<b>_LongHeader</b>	

## Addresses configuration

- ATS097: Expeditor address
- ATS090: Destination address

Radio Addresses

ATS	bit	Parameters	Value	Register value
090	0:7	Adresse destinataire (modem distant)	0x01 à 0xFF	0xFF
097	0:7	Adresse expéditeur (modem local)	0x00 à 0xFE	0x00



Filter rules (in reception) of the message sent the modem A and received by the modem B:

Message ok = ((EXP<sub>A</sub> != EXP<sub>B</sub>) OU (EXP<sub>A</sub> == 0x00)) ET ((DEST<sub>A</sub> == EXP<sub>B</sub>) OU (DEST<sub>A</sub> == 0xFF))

### iii. Radio channels

To respect the spectral congestion in the used band (863MHz to 870MHz), the channels are restricted according to the baudrate.

The list of channels is in the annexes.

Channel (hexadecimal)	Frequency		Quantity of available channels							
			1,2 kbps	2,4 kbps	4,8 kbps	9,6 kbps	19,2 kbps	38,4 kbps	57,6 kbps	115,2 kbps
0000	863,0000	NC	NONE	NONE	NONE	NONE	NONE	NONE	NONE	NONE
0001 to 018F	863,0125	14 dBm - 25mW	399	399	399	199	132	99	65	24
	867,9875									
0190	868,0000		NONE	NONE	NONE	NONE	NONE	NONE	NONE	NONE
0191 to 01BF	868,0125	14 dBm - 25mW	47	47	47	23	14	11	7	2
	868,5875									
01C0 to 01C8	868,6000	NC	NONE	NONE	NONE	NONE	NONE	NONE	NONE	NONE
	868,7000									
01C9 to 01EF	868,7125	14 dBm - 25mW	39	39	39	19	12	9	5	2
	869,1875									
01F0 to 0200	869,2000	NC	NONE	NONE	NONE	NONE	NONE	NONE	NONE	NONE
	869,4000									
0201 to 0213	869,4125	27 dBm - 500mW	19	19	19	9	5	7	3	1
	869,6375									
0214 to 0218	869,6500	NC	NONE	NONE	NONE	NONE	NONE	NONE	NONE	NONE
	869,7000									
0219 to 022F	869,7125	14 dBm - 25mW	23	23	23	11	6	5	3	1
	869,9875									
Quantity of channels			527	527	527	261	169	131	83	30

Table 2 : Available channels from 863 to 870 MHz

### iv. Whitening

For an ideal data transmission in radio, the data repartition is random and without a continuous component. The power spectral density is then well divided. In reality, the data can contain long sequences of zero and/or ones that can cause a loss in the synchronization of the clocks between the sender and the receiver, the whitening technique applies a transcoding that enables to reduce these long sequences of bytes in this same state.

ATS	bit	Parameters	Register value
093	0	_RxToleranceLow	C0
	1	_PADisabled	
	2-4	_CC_CCA	
	5	_Whitening	
	6	_AttachCRC	
	7	_LongHeader	

## v. Listen before talk (LBT)

The LBT technique is principally made to improve the radio-electric spectral efficiency of the 863-870 MHz band. When a modem wants to emit, it listens to the network to see if another emission is being done at the same time (Presence or not of a magnitude signal bigger or equal to the detection limit). If it is, it will wait for a pseudo random time between 1 to 5 ms and re-listens, otherwise it sends straight away.

The equipment's that use the LBT are not limited to a cyclic report. If the LBT is not used, a cyclic report must be done according to the ERC 70-03 [2] recommendation.

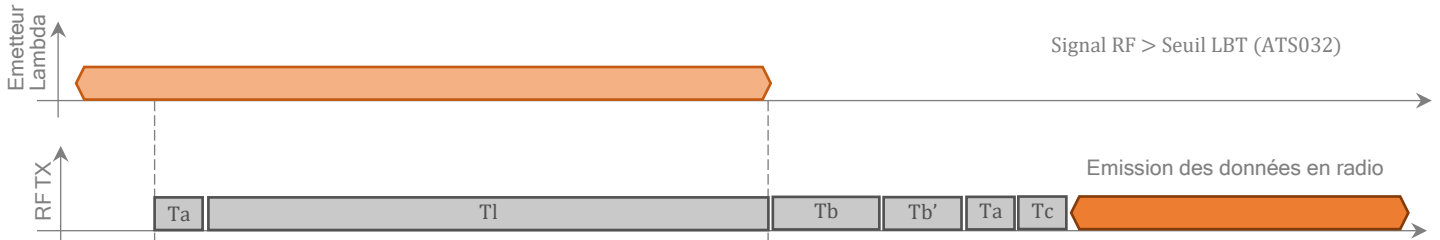

Ta : Times 'Listen before talk' 5ms

Tl : Listening duration

Tb : Time random alias 'Listen before talk'

Tb' : Extra time (ATS056 from 0 to 255ms)

Tc : Time before remaining radio emission (ATS017)

Carrier limit detection

ATS	bit	Parameters	Register value
032	0:7	Seuil de -127 à 0 dBm (octet signé)	-95dm = 0xA1

Additional time post LBT

ATS	bit	Parameters	Register value
056	0:7	Temps de 0 à 255ms	0x00

Activation LBT

ATS	bit	Parameters	Register value
092	0	<b>_ListenBeforeTalkEnabled</b>	0x40
	1	_AFAEnabled	
	2	_LongPreamble	
	3	_WOR_CS	
	4	_NC	
	5	_NC	
	6	_VariablePacketLength	
	7	_InfinitePacketLength	

The LBT limit is entered as a signed byte. It is recommended to not go under -105dbm.

The added time (Tb') enables to wait a little before sending and to disrupt a possible response to the emission Lambda signal.

## vi. Adaptive Frequency Agility (AFA)

The AFA is a technique used to avoid emitting on a channel that is already used. If this function is activated, the receiver looks at the chosen channels permanently (principal channel and secondary channel) and uses the unoccupied one now the data is sent to avoid any interferences.

Activation AFA

ATS	bit	Parameters	Register value
092	0	_ListenBeforeTalkEnabled	0x40
	1	<b>_AFAEnabled</b>	
	2	_LongPreamble	
	3	_WOR_CS	
	4	_NC	
	5	_NC	
	6	_VariablePacketLength	
	7	_InfinitePacketLength	

Principal radio channel

ATS	bit	Parameters	Value	Register value
002	0:7	Canal radio Tx - Rx LSB	560 channels from 863 to 870 MHz	02
003	0:7	Canal radio Tx - Rx MSB	560 channels from 863 to 870 MHz	0A

Secondary radio channel

ATS	bit	Parameters	Value	Register value
026	0:7	Canal radio Tx - Rx LSB	560 channels from 863 to 870 MHz	40
027	0:7	Canal radio Tx - Rx MSB	560 channels from 863 to 870 MHz	00

## vii. Repeater

The repeater is based on an active AFA functioning (Active repeater -> AFA automatically activated). The checked channels are used to transmit on the secondary channel (ATS026-027) the received data on the principal channel (ATS002-003) et inversely.

ATS	bit	Parameters	Register value
069	0	<b>_RepeaterEnable</b>	00
	1	_NC	
	2	_NC	
	3	_NC	
	4	_NC	
	5	_NC	
	6	_NC	
	7	_NC	

## Sleep mode

### i. Sleep/wake-up sources

There exists many wake up sources on the ARM-Nx module:

1. Digital input on the pin INTO : maintain of INTO at 1 (VDD) during 1,5ms minimum. Activated for **ATS062 bit7 =1**.
2. Receiving a character on Rx UART (without losing the wake up for data rate UART <57600bps). Activated for **ATS062 bit4 = 1**.
3. Frame reception on the SPI bus. Active by default if SPI bus is used.
4. Radio in WOR mode. Active for **ATS063 bit7 =1**.

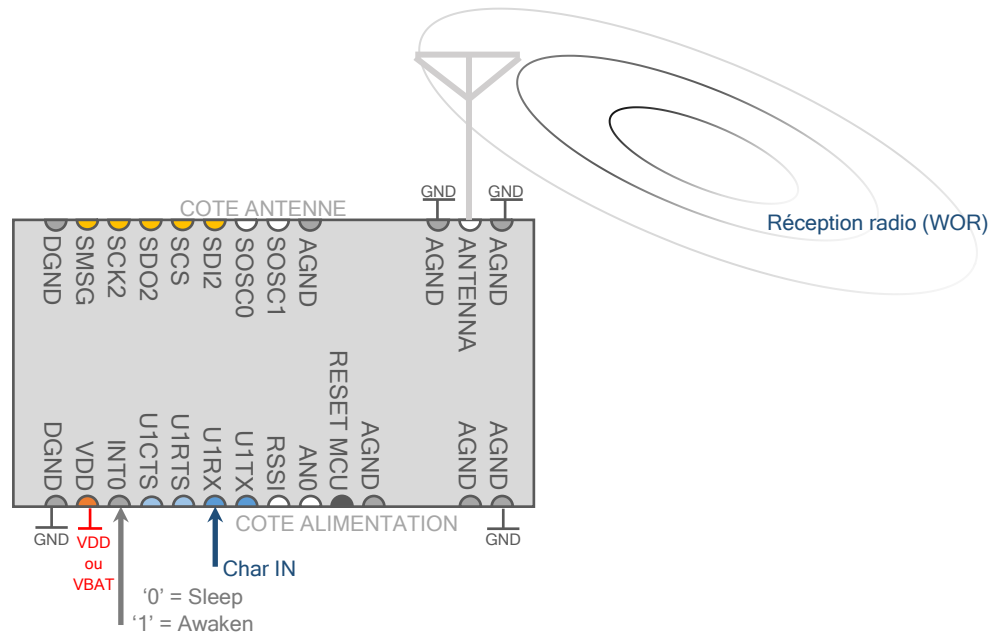

### ii. Entrance and exit of the sleep mode condition

**Entrance in sleep mode =**

**$(INTO==0) \ \&\& \text{Aucun Traitement Série} \ \&\& \text{Aucun Traitement Radio} \ \&\& \text{Fenêtre Post-Wor dépassée}$**

**Exit sleep mode =**

**$(INTO==1) \ || \ (RxUART) \ || \ \text{Traitement Série} \ || \ \text{Traitement Radio} \ || \ \text{Sniff} \ || \ \text{Fenêtre Post-Wor active}$**

Serial treatment: serial buffer not empty

Radio treatment: no radio task (Tx,Rx,etc.) pending

## Sleep mode configuration

Power supply wake up sources pins

ATS	bit	Parameters	Register value
062	0	_Reset	00
	1	_AN0	
	2	_RSSI	
	3	_U1TX	
	4	_U1RX	
	5	_U1RTS	
	6	_U1CTS	
	7	_INT0	

Antenna wake up sources' pins

ATS	bit	Parameters	Register value
063	0	SMSG	00
	1	_SCK2	
	2	_SDO2	
	3	_SCS	
	4	_SDI2	
	5	_OSC0	
	6	_OSC1	
	7	_RF	

Wake up window time

ATS	bit	Parameters	Register value
066	0:7	Window time 10 x ms before going asleep. Relunched at every Rx UART, end of Tx-Rx Radio,	0x02



# Wake On Radio (WOR)

## i. Principal

To optimize the consumed current during the radio reception phase, the ARM-Nano module is capable of waking up periodically, go into reception mode for a little time and then go back into sleep mode. This functioning mode forces the sender to extend the preamble emission time to keep track of the wake-up receptors period.

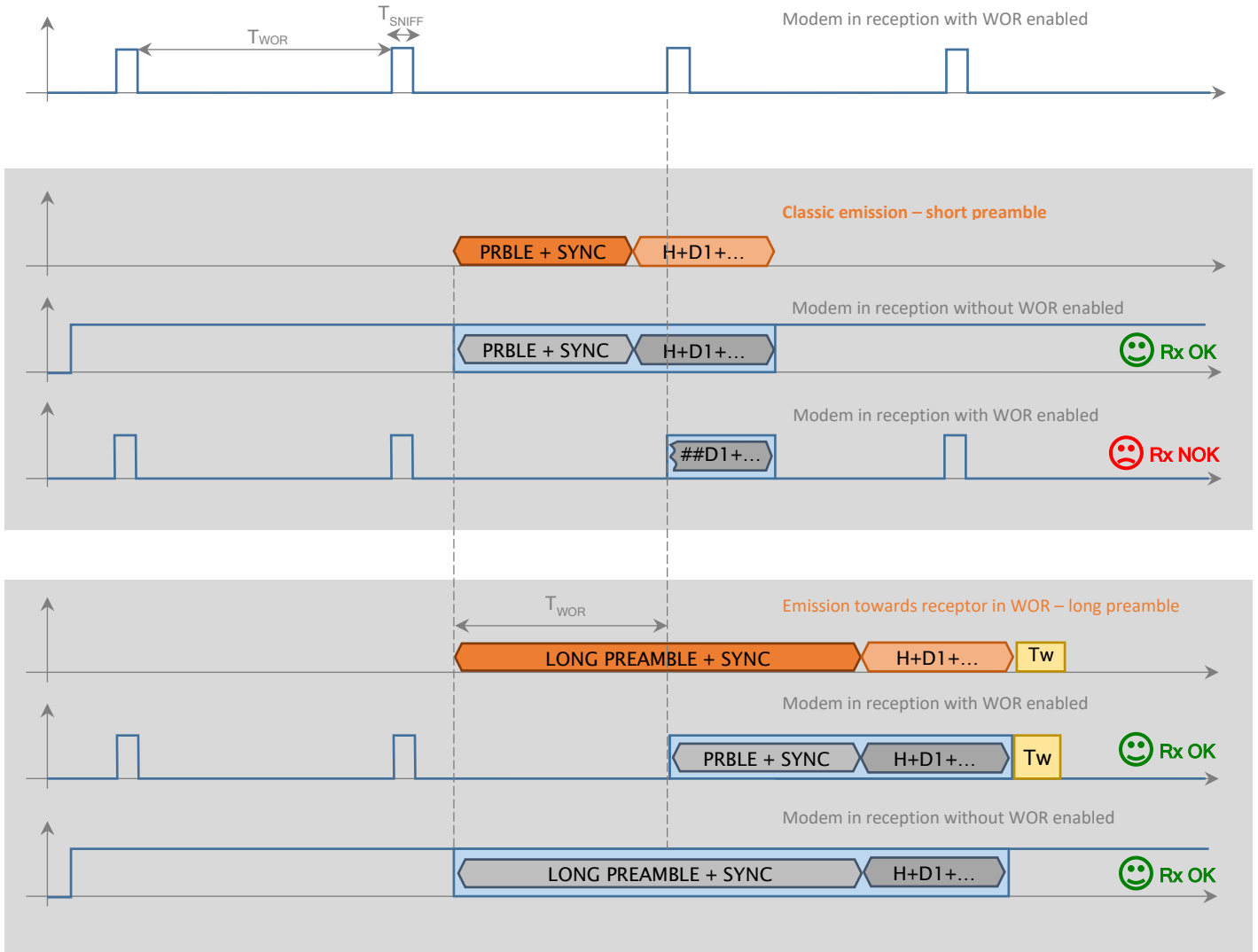

$T_{WOR}$  : wake-up period for the radio reception/listening. See ATS064-ATS065.

$T_{SNIFF}$  : wake-up time (unconfigurable, depends on the WOR reception method). See ATS092 bit3.

$T_w$  : timelaps post-WOR. During this period the WOR mode is disabled on the receptor side (no standby return) and on the emeter side as well (no emission with long preamble). This timelaps allows normal emissions/receptions before the WOR mode return. See ATS066.

## Note

To make the modem configuration, the AT5064-065 parameter defines the wake-up period on the receptors side and the extra time on the preamble senders. You only need to then activate the long preamble (AT5092 bit2 senders' side) and WOR (AT5063 bit7 receptors side).

### ii. WOR reception method

This method is based on a modulated carrier detection (CS - Carrier Sense) (AT5092.bit3=1) : When the wakes up to receive, the listen focuses on the RF signal level centered on the receivers frequency. If this signal exceeds the detection level setted in AT5032, the modem continues to listen or goes immediately to sleep.

#### Advantages

- ✓ Listen time ( $T_{\text{SNIFF}}$ ) very short (<5ms)

#### Disadvantages

- ✗ Sensible to noise

This method is based on the verifying the preamble (PQT – Preamble Quality Threshold) (AT5092.bit3=0): When the modem wakes up to receive, the listening is focused on the preamble detection of an RF signal centered on the frequency of the receiver. The quality criteria of the preamble is not adjustable, if no preamble is seen over a certain time (not adjustable), the modem goes back in sleep mode.

#### Advantages

- ✓ interferences/noise robustness

#### Disadvantages

- ✗ listening time ( $T_{\text{SNIFF}}$ ) long (>5ms : Baudrate dependant)

### iii. Post-WOR treatment

The frame exchanges in WOR mode can heavily penalize the systems latency time. To minimize this latency, the window post-WOR (AT5066) enables to maintain the modem in a normal state for 2,55 seconds maximum (AT5066=FF).

- Emitters side of a long preamble is deactivated during this period (launched at the end of the).
- Receivers side the modem does not go back into sleep mode and receives the radio messages normally during this period (launched at the end of the reception).

The window post-WOR is re-opened after these events:

- Radio initialization
- End of reception or end of radio emission
- End of reception or end of serial byte emission

#### iv. Wake up events (example)

##### Emission side

- ✓ Wake-up INTO : AT5062 bit7 = 1
- ✓ Wake-up Rx UART : AT5062 bit4 = 1
- ✓ Emission long preamble : AT5092 bit2 = 1
- ✓ Emission time preamble :  
AT5064-65=0x01F4 (500ms)
- ✓ window post-WOR at 100ms : AT5066=0A

##### Receiving side

- ✓ Wake-up INTO : AT5062 bit7 = 1
- ✓ Wake-up Rx RF : AT5063 bit7 = 1
- ✓ WOR-PQT method : AT5092 bit3 = 0
- ✓ WOR period:  
AT5064-65=0x01F4 (500ms)
- ✓ Window post-WOR at 100ms : AT5066=0A

## Configuration register

Power supply wake up sources' pins

ATS	bit	Parameter	Register value
062	0	<u>Reset</u>	00
	1	<u>AN0</u>	
	2	<u>RSSI</u>	
	3	<u>U1TX</u>	
	4	<u>U1RX</u>	
	5	<u>U1RTS</u>	
	6	<u>U1CTS</u>	
	7	<u>INT0</u>	

Antenna wake up sources' pins

ATS	bit	Parameter	Register value
063	0	<u>SMSG</u>	00
	1	<u>SCK2</u>	
	2	<u>SDO2</u>	
	3	<u>SCS</u>	
	4	<u>SDI2</u>	
	5	<u>OSC0</u>	
	6	<u>OSC1</u>	
	7	<u>RF</u>	

WOR period / Extra time preamble

ATS	bit	Parameters	Value
064	0:7	Time in ms. LSB	0xF4
065	0:7	Time in ms. MSB	0x01

Window awake time post-WOR

ATS	bit	Parameters	Register value
066	0:7	Window time 10 x ms before going asleep. Relunched at every Rx UART, end of Tx-Rx Radio,	0x00

WOR Mode

ATS	bit	Parameters	Register value
092	0	<u>ListenBeforeTalkEnabled</u>	0x4X
	1	<u>AFAEnabled</u>	
	2	<u>LongPreamble</u>	
	3	<u>WOR_CS</u>	
	4	<u>NC</u>	
	5	<u>NC</u>	
	6	<u>VariablePacketLength</u>	
	7	<u>InfinitePacketLength</u>	

## Signalizations

It is possible to see certain events or functioning phases thanks to:

- The green LED on the modem
- Pin RSSI (pin 20 : see **¡Error! No se encuentra el origen de la referencia. ¡Error! No se encuentra el origen de la referencia.**)

LED ON when Tx or Rx radio only. LED OFF the rest of the time : ATS025.bit0=1

LED ON permanent. LED OFF when Tx or Rx radio only : ATS025.bit1=1

LED ON on over limit RSSI (RSSI>ATS032), LED OFF under the limit : ATS025.bit6=1

PIN RSSI = 1 when radio reception in progress: ATS025.bit2=1

PIN RSSI = 1 when radio transmission in progress : ATS025.bit3=1

PIN RSSI = 1 when Radio transmission sees an LBT : ATS025.bit4=1

PIN RSSI = 1 on over limit RSSI (RSSI>ATS032), LED OFF under limit: ATS025.bit6=1

PIN RSSI = PWM (analog<sup>4</sup> signal) according to actual RSSI : ATS025.bit7 = 1. (unavailable for Sigfox modems).

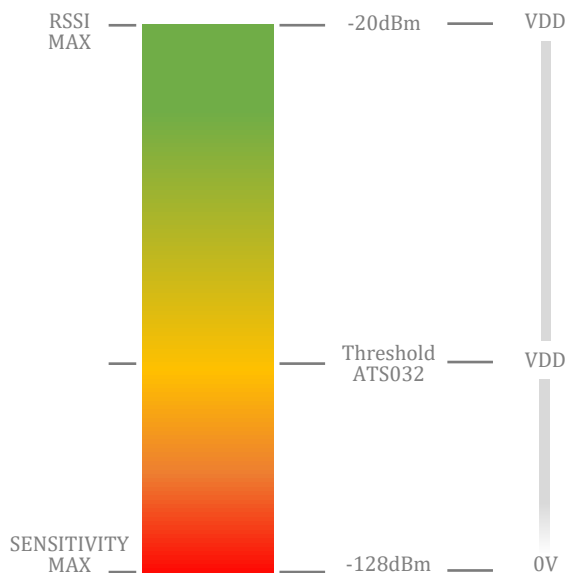

ATS	bit	Parameters	Register value
025	0	_TxRxLEDON	02
	1	_TxRxLEDOFF	
	2	_RxPacket	
	3	_TxPacket	
	4	_CS_LBT	
	5	_CS_RX	
	6	_CsLEDON	
	7	_CS_PWM	

<sup>4</sup> To obtain an analogical signal, adding a RC filter on the output of pin 20 should be done (R=1,2kΩ ; C=100nF)



## Consumed current Optimization

Many factors impact the modems:

1. Radio Emission phase (adjustable output power with ATS004)
2. Receiving radio phase (adjustable via WOR)
3. LED activity (adjustable with ATS025)
4. Power calculation (maxi when PLL activated ATS001, bit2. When the SPI bus is used or for the data rates by UART > 57600bps, the PLL is automatically activated)
5. Microcontroller functioning mode: when the processor is not used it is put in IDLE mode (ATS001.bit0=1)

Staged radio output power

ATS	bit	Parameters	Register value
004	0:7	Pout radio	TBD = 0xFF (voir S062) REGUL = 0x00 0dBm = 0x01 5dBm = 0x02 7dBm = 0x03 10dBm = 0x04 12dBm = 0x05 14dBm = 0x06 20dBm=0x07 (LD) 23dBm=0x08 (LD) 27dBm=0x09 (LD)

Wake On Radio

ATS	bit	Parameters	Value	Register value
092	0	_ListenBeforeTalkEnabled	X	XX
	1	_AFAEnabled	0	
	2	_LongPreamble	X	
	3	_WOR_CS	X	
	4	_NC	X	
	5	_LongPrbleOnly4WakeUp	X	
	6	_VariablePacketLength	X	
	7	_InfinitePacketLength	X	

Power supply wake up sources' pins

ATS	bit	Parameters	Value	Register value
062	0	_Reset	0	X0
	1	_AN0	0	
	2	_RSSI	0	
	3	_U1TX	0	
	4	_U1RX	X	
	5	_U1RTS	0	
	6	_U1CTS	0	
	7	_INT0	X	

Antenna wake up sources' pins

ATS	bit	Parameters	Value	Register value
063	0	_INT2	0	XX
	1	_SCK2	0	
	2	_SDO2	0	
	3	_SCS	0	
	4	_SDI2	0	
	5	_OSC0	0	
	6	_OSC1	0	
	7	_RF	X	

Consumption parameters

ATS	bit	Parameters	Value	Register value
001	0	_Idle	0	0x28
	1	_Sleep	0	
	2	_Force_PLLx4	0	
	3	_MCU_ExtClock	1	
	4	_NC	0	
	5	_BOR_Enabled	1	
	6	_NC	0	
	7	_NoExtFlash	0	

Devices control





ATS	bit	Parameters	Value	Register value
025	0	_TxRxLEDON	0	0x02
	1	_TxRxLEDOFF	1	
	2	_RxPacket	0	
	3	_TxPacket	0	
	4	_CS_LBT	0	
	5	_CS_RX	0	
	6	_CsLEDON	0	
	7	_CS_PWM	0	

## Firmware update by bootloader

### i. Versions

The bootloader version is known thanks to the color on the microcontroller

The update package is available here: [http://www.atim.com/download/UPDATE\\_PACK\\_ARM-NANO.zip](http://www.atim.com/download/UPDATE_PACK_ARM-NANO.zip)

Mark	Bootloader Version	Encryption	Client Software	Features	BOR Level
	1	NO	ds30Loader	None	LP_BOR
	2	YES	ds30SecureLoader / Upgrader	Encryption	2,7V
	3	YES	ds30SecureLoader / Upgrader	Encryption / Fast boot - No bootloader with CTS='1'	2,7V
	4	YES	ds30SecureLoader / Upgrader	Encryption / Fast boot - No bootloader with CTS='1'	1,8V

### ii. Using the Upgrader.exe

File ARM-N8-Lx-Vxxx\_encrypted.hex to load

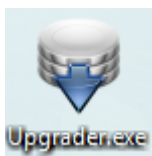

Click on « Update » during the next "seconds after the power up or RESET (see pin RESET of the module)

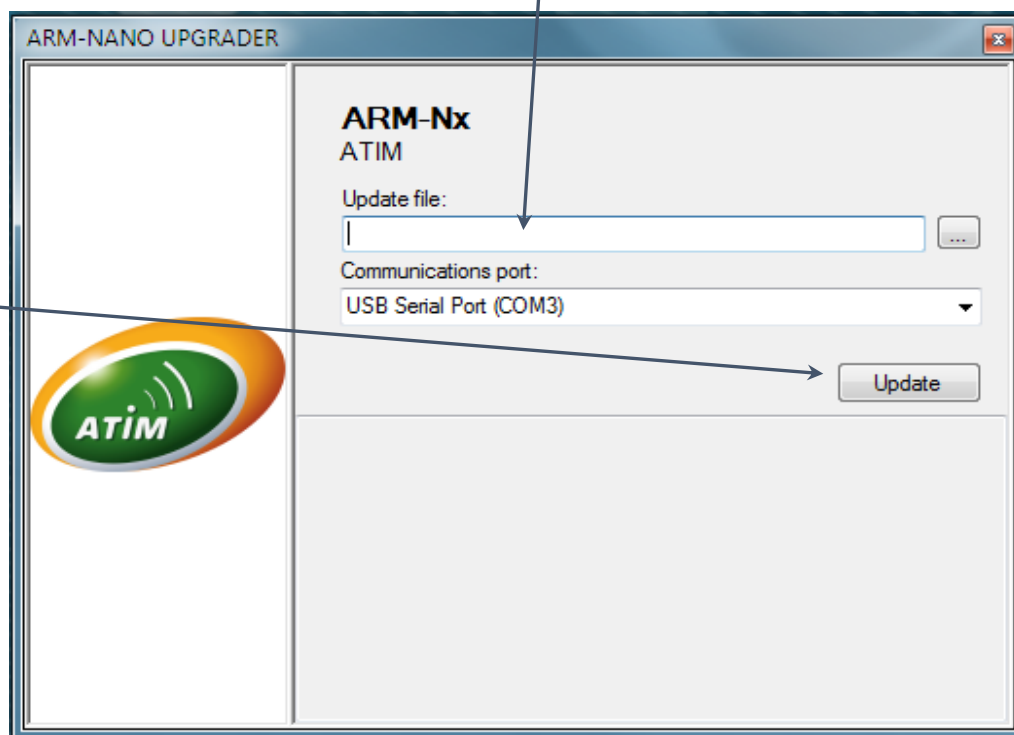

#### Note

For the version with a bootloader over 2, The execution of the bootloader depends on the state, when started, of the CTS pin.

If CTS = 1 (Vdd) The bootloader program does not launch.

If CTS = 0 or HIGH Z, the bootloader program launches normally.



## Frequency table

Channel		Freq.	1,2 kbps	2,4 kbps	4,8 kbps	9,6 kbps	19,2 kbps	38,4 kbps	57,6 kbps	115,2 kbps
dec.	hex.									
0	0000	863,0000								
1	0001	863,0125	14dBm	14dBm	14dBm					
2	0002	863,0250	14dBm	14dBm	14dBm	14dBm				
3	0003	863,0375	14dBm	14dBm	14dBm					
4	0004	863,0500	14dBm	14dBm	14dBm	14dBm	14dBm	14dBm		
5	0005	863,0625	14dBm	14dBm	14dBm				14dBm	
6	0006	863,0750	14dBm	14dBm	14dBm	14dBm				
7	0007	863,0875	14dBm	14dBm	14dBm		14dBm			
8	0008	863,1000	14dBm	14dBm	14dBm	14dBm		14dBm		14dBm
9	0009	863,1125	14dBm	14dBm	14dBm					
10	000A	863,1250	14dBm	14dBm	14dBm	14dBm	14dBm			
11	000B	863,1375	14dBm	14dBm	14dBm				14dBm	
12	000C	863,1500	14dBm	14dBm	14dBm	14dBm		14dBm		
13	000D	863,1625	14dBm	14dBm	14dBm		14dBm			
14	000E	863,1750	14dBm	14dBm	14dBm	14dBm				
15	000F	863,1875	14dBm	14dBm	14dBm					
16	0010	863,2000	14dBm	14dBm	14dBm	14dBm	14dBm	14dBm		
17	0011	863,2125	14dBm	14dBm	14dBm				14dBm	
18	0012	863,2250	14dBm	14dBm	14dBm	14dBm				
19	0013	863,2375	14dBm	14dBm	14dBm		14dBm			
20	0014	863,2500	14dBm	14dBm	14dBm	14dBm		14dBm		
21	0015	863,2625	14dBm	14dBm	14dBm					
22	0016	863,2750	14dBm	14dBm	14dBm	14dBm	14dBm			
23	0017	863,2875	14dBm	14dBm	14dBm				14dBm	
24	0018	863,3000	14dBm	14dBm	14dBm	14dBm		14dBm		14dBm
25	0019	863,3125	14dBm	14dBm	14dBm		14dBm			
26	001A	863,3250	14dBm	14dBm	14dBm	14dBm				
27	001B	863,3375	14dBm	14dBm	14dBm					
28	001C	863,3500	14dBm	14dBm	14dBm	14dBm	14dBm	14dBm		
29	001D	863,3625	14dBm	14dBm	14dBm				14dBm	
30	001E	863,3750	14dBm	14dBm	14dBm	14dBm				
31	001F	863,3875	14dBm	14dBm	14dBm		14dBm			
32	0020	863,4000	14dBm	14dBm	14dBm	14dBm		14dBm		
33	0021	863,4125	14dBm	14dBm	14dBm					
34	0022	863,4250	14dBm	14dBm	14dBm	14dBm	14dBm			
35	0023	863,4375	14dBm	14dBm	14dBm				14dBm	
36	0024	863,4500	14dBm	14dBm	14dBm	14dBm		14dBm		
37	0025	863,4625	14dBm	14dBm	14dBm		14dBm			
38	0026	863,4750	14dBm	14dBm	14dBm	14dBm				
39	0027	863,4875	14dBm	14dBm	14dBm					
40	0028	863,5000	14dBm	14dBm	14dBm	14dBm	14dBm	14dBm		14dBm
41	0029	863,5125	14dBm	14dBm	14dBm				14dBm	

Channel		Freq.	1,2 kbps	2,4 kbps	4,8 kbps	9,6 kbps	19,2 kbps	38,4 kbps	57,6 kbps	115,2 kbps
dec.	hex.									
42	002A	863,5250	14dBm	14dBm	14dBm	14dBm				
43	002B	863,5375	14dBm	14dBm	14dBm		14dBm			
44	002C	863,5500	14dBm	14dBm	14dBm	14dBm		14dBm		
45	002D	863,5625	14dBm	14dBm	14dBm					
46	002E	863,5750	14dBm	14dBm	14dBm	14dBm	14dBm			
47	002F	863,5875	14dBm	14dBm	14dBm				14dBm	
48	0030	863,6000	14dBm	14dBm	14dBm	14dBm		14dBm		
49	0031	863,6125	14dBm	14dBm	14dBm		14dBm			
50	0032	863,6250	14dBm	14dBm	14dBm	14dBm				
51	0033	863,6375	14dBm	14dBm	14dBm					
52	0034	863,6500	14dBm	14dBm	14dBm	14dBm	14dBm	14dBm		
53	0035	863,6625	14dBm	14dBm	14dBm				14dBm	
54	0036	863,6750	14dBm	14dBm	14dBm	14dBm				
55	0037	863,6875	14dBm	14dBm	14dBm		14dBm			
56	0038	863,7000	14dBm	14dBm	14dBm	14dBm		14dBm		14dBm
57	0039	863,7125	14dBm	14dBm	14dBm					
58	003A	863,7250	14dBm	14dBm	14dBm	14dBm	14dBm			
59	003B	863,7375	14dBm	14dBm	14dBm				14dBm	
60	003C	863,7500	14dBm	14dBm	14dBm	14dBm		14dBm		
61	003D	863,7625	14dBm	14dBm	14dBm		14dBm			
62	003E	863,7750	14dBm	14dBm	14dBm	14dBm				
63	003F	863,7875	14dBm	14dBm	14dBm					
64	0040	863,8000	14dBm	14dBm	14dBm	14dBm	14dBm	14dBm		
65	0041	863,8125	14dBm	14dBm	14dBm				14dBm	
66	0042	863,8250	14dBm	14dBm	14dBm	14dBm				
67	0043	863,8375	14dBm	14dBm	14dBm		14dBm			
68	0044	863,8500	14dBm	14dBm	14dBm	14dBm		14dBm		
69	0045	863,8625	14dBm	14dBm	14dBm					
70	0046	863,8750	14dBm	14dBm	14dBm	14dBm	14dBm			
71	0047	863,8875	14dBm	14dBm	14dBm				14dBm	
72	0048	863,9000	14dBm	14dBm	14dBm	14dBm		14dBm		14dBm
73	0049	863,9125	14dBm	14dBm	14dBm		14dBm			
74	004A	863,9250	14dBm	14dBm	14dBm	14dBm				
75	004B	863,9375	14dBm	14dBm	14dBm					
76	004C	863,9500	14dBm	14dBm	14dBm	14dBm	14dBm	14dBm		
77	004D	863,9625	14dBm	14dBm	14dBm				14dBm	
78	004E	863,9750	14dBm	14dBm	14dBm	14dBm				
79	004F	863,9875	14dBm	14dBm	14dBm		14dBm			
80	0050	864,0000	14dBm	14dBm	14dBm	14dBm		14dBm		
81	0051	864,0125	14dBm	14dBm	14dBm					
82	0052	864,0250	14dBm	14dBm	14dBm	14dBm	14dBm			
83	0053	864,0375	14dBm	14dBm	14dBm				14dBm	
84	0054	864,0500	14dBm	14dBm	14dBm	14dBm		14dBm		
85	0055	864,0625	14dBm	14dBm	14dBm		14dBm			

Channel		Freq.	1,2 kbps	2,4 kbps	4,8 kbps	9,6 kbps	19,2 kbps	38,4 kbps	57,6 kbps	115,2 kbps
dec.	hex.									
86	0056	864,0750	14dBm	14dBm	14dBm	14dBm				
87	0057	864,0875	14dBm	14dBm	14dBm					
88	0058	864,1000	14dBm	14dBm	14dBm	14dBm	14dBm	14dBm		14dBm
89	0059	864,1125	14dBm	14dBm	14dBm				14dBm	
90	005A	864,1250	14dBm	14dBm	14dBm	14dBm				
91	005B	864,1375	14dBm	14dBm	14dBm		14dBm			
92	005C	864,1500	14dBm	14dBm	14dBm	14dBm		14dBm		
93	005D	864,1625	14dBm	14dBm	14dBm					
94	005E	864,1750	14dBm	14dBm	14dBm	14dBm	14dBm			
95	005F	864,1875	14dBm	14dBm	14dBm				14dBm	
96	0060	864,2000	14dBm	14dBm	14dBm	14dBm		14dBm		
97	0061	864,2125	14dBm	14dBm	14dBm		14dBm			
98	0062	864,2250	14dBm	14dBm	14dBm	14dBm				
99	0063	864,2375	14dBm	14dBm	14dBm					
100	0064	864,2500	14dBm	14dBm	14dBm	14dBm	14dBm	14dBm		
101	0065	864,2625	14dBm	14dBm	14dBm				14dBm	
102	0066	864,2750	14dBm	14dBm	14dBm	14dBm				
103	0067	864,2875	14dBm	14dBm	14dBm		14dBm			
104	0068	864,3000	14dBm	14dBm	14dBm	14dBm		14dBm		14dBm
105	0069	864,3125	14dBm	14dBm	14dBm					
106	006A	864,3250	14dBm	14dBm	14dBm	14dBm	14dBm			
107	006B	864,3375	14dBm	14dBm	14dBm				14dBm	
108	006C	864,3500	14dBm	14dBm	14dBm	14dBm		14dBm		
109	006D	864,3625	14dBm	14dBm	14dBm		14dBm			
110	006E	864,3750	14dBm	14dBm	14dBm	14dBm				
111	006F	864,3875	14dBm	14dBm	14dBm					
112	0070	864,4000	14dBm	14dBm	14dBm	14dBm	14dBm	14dBm		
113	0071	864,4125	14dBm	14dBm	14dBm				14dBm	
114	0072	864,4250	14dBm	14dBm	14dBm	14dBm				
115	0073	864,4375	14dBm	14dBm	14dBm		14dBm			
116	0074	864,4500	14dBm	14dBm	14dBm	14dBm		14dBm		
117	0075	864,4625	14dBm	14dBm	14dBm					
118	0076	864,4750	14dBm	14dBm	14dBm	14dBm	14dBm			
119	0077	864,4875	14dBm	14dBm	14dBm				14dBm	
120	0078	864,5000	14dBm	14dBm	14dBm	14dBm		14dBm		14dBm
121	0079	864,5125	14dBm	14dBm	14dBm		14dBm			
122	007A	864,5250	14dBm	14dBm	14dBm	14dBm				
123	007B	864,5375	14dBm	14dBm	14dBm					
124	007C	864,5500	14dBm	14dBm	14dBm	14dBm	14dBm	14dBm		
125	007D	864,5625	14dBm	14dBm	14dBm				14dBm	
126	007E	864,5750	14dBm	14dBm	14dBm	14dBm				
127	007F	864,5875	14dBm	14dBm	14dBm		14dBm			
128	0080	864,6000	14dBm	14dBm	14dBm	14dBm		14dBm		
129	0081	864,6125	14dBm	14dBm	14dBm					

Channel		Freq.	1,2 kbps	2,4 kbps	4,8 kbps	9,6 kbps	19,2 kbps	38,4 kbps	57,6 kbps	115,2 kbps
dec.	hex.									
130	0082	864,6250	14dBm	14dBm	14dBm	14dBm	14dBm			
131	0083	864,6375	14dBm	14dBm	14dBm				14dBm	
132	0084	864,6500	14dBm	14dBm	14dBm	14dBm		14dBm		
133	0085	864,6625	14dBm	14dBm	14dBm		14dBm			
134	0086	864,6750	14dBm	14dBm	14dBm	14dBm				
135	0087	864,6875	14dBm	14dBm	14dBm					
136	0088	864,7000	14dBm	14dBm	14dBm	14dBm	14dBm	14dBm		14dBm
137	0089	864,7125	14dBm	14dBm	14dBm				14dBm	
138	008A	864,7250	14dBm	14dBm	14dBm	14dBm				
139	008B	864,7375	14dBm	14dBm	14dBm		14dBm			
140	008C	864,7500	14dBm	14dBm	14dBm	14dBm		14dBm		
141	008D	864,7625	14dBm	14dBm	14dBm					
142	008E	864,7750	14dBm	14dBm	14dBm	14dBm	14dBm			
143	008F	864,7875	14dBm	14dBm	14dBm				14dBm	
144	0090	864,8000	14dBm	14dBm	14dBm	14dBm		14dBm		
145	0091	864,8125	14dBm	14dBm	14dBm		14dBm			
146	0092	864,8250	14dBm	14dBm	14dBm	14dBm				
147	0093	864,8375	14dBm	14dBm	14dBm					
148	0094	864,8500	14dBm	14dBm	14dBm	14dBm	14dBm	14dBm		
149	0095	864,8625	14dBm	14dBm	14dBm				14dBm	
150	0096	864,8750	14dBm	14dBm	14dBm	14dBm				
151	0097	864,8875	14dBm	14dBm	14dBm		14dBm			
152	0098	864,9000	14dBm	14dBm	14dBm	14dBm		14dBm		14dBm
153	0099	864,9125	14dBm	14dBm	14dBm					
154	009A	864,9250	14dBm	14dBm	14dBm	14dBm	14dBm			
155	009B	864,9375	14dBm	14dBm	14dBm				14dBm	
156	009C	864,9500	14dBm	14dBm	14dBm	14dBm		14dBm		
157	009D	864,9625	14dBm	14dBm	14dBm		14dBm			
158	009E	864,9750	14dBm	14dBm	14dBm	14dBm				
159	009F	864,9875	14dBm	14dBm	14dBm					
160	00A0	865,0000	14dBm	14dBm	14dBm	14dBm	14dBm	14dBm		
161	00A1	865,0125	14dBm	14dBm	14dBm				14dBm	
162	00A2	865,0250	14dBm	14dBm	14dBm	14dBm				
163	00A3	865,0375	14dBm	14dBm	14dBm		14dBm			
164	00A4	865,0500	14dBm	14dBm	14dBm	14dBm		14dBm		
165	00A5	865,0625	14dBm	14dBm	14dBm					
166	00A6	865,0750	14dBm	14dBm	14dBm	14dBm	14dBm			
167	00A7	865,0875	14dBm	14dBm	14dBm				14dBm	
168	00A8	865,1000	14dBm	14dBm	14dBm	14dBm		14dBm		14dBm
169	00A9	865,1125	14dBm	14dBm	14dBm		14dBm			
170	00AA	865,1250	14dBm	14dBm	14dBm	14dBm				
171	00AB	865,1375	14dBm	14dBm	14dBm					
172	00AC	865,1500	14dBm	14dBm	14dBm	14dBm	14dBm	14dBm		
173	00AD	865,1625	14dBm	14dBm	14dBm				14dBm	

Channel		Freq.	1,2 kbps	2,4 kbps	4,8 kbps	9,6 kbps	19,2 kbps	38,4 kbps	57,6 kbps	115,2 kbps
dec.	hex.									
174	00AE	865,1750	14dBm	14dBm	14dBm	14dBm				
175	00AF	865,1875	14dBm	14dBm	14dBm		14dBm			
176	00B0	865,2000	14dBm	14dBm	14dBm	14dBm		14dBm		
177	00B1	865,2125	14dBm	14dBm	14dBm					
178	00B2	865,2250	14dBm	14dBm	14dBm	14dBm	14dBm			
179	00B3	865,2375	14dBm	14dBm	14dBm				14dBm	
180	00B4	865,2500	14dBm	14dBm	14dBm	14dBm		14dBm		
181	00B5	865,2625	14dBm	14dBm	14dBm		14dBm			
182	00B6	865,2750	14dBm	14dBm	14dBm	14dBm				
183	00B7	865,2875	14dBm	14dBm	14dBm					
184	00B8	865,3000	14dBm	14dBm	14dBm	14dBm	14dBm	14dBm		14dBm
185	00B9	865,3125	14dBm	14dBm	14dBm				14dBm	
186	00BA	865,3250	14dBm	14dBm	14dBm	14dBm				
187	00BB	865,3375	14dBm	14dBm	14dBm		14dBm			
188	00BC	865,3500	14dBm	14dBm	14dBm	14dBm		14dBm		
189	00BD	865,3625	14dBm	14dBm	14dBm					
190	00BE	865,3750	14dBm	14dBm	14dBm	14dBm	14dBm			
191	00BF	865,3875	14dBm	14dBm	14dBm				14dBm	
192	00C0	865,4000	14dBm	14dBm	14dBm	14dBm		14dBm		
193	00C1	865,4125	14dBm	14dBm	14dBm		14dBm			
194	00C2	865,4250	14dBm	14dBm	14dBm	14dBm				
195	00C3	865,4375	14dBm	14dBm	14dBm					
196	00C4	865,4500	14dBm	14dBm	14dBm	14dBm	14dBm	14dBm		
197	00C5	865,4625	14dBm	14dBm	14dBm				14dBm	
198	00C6	865,4750	14dBm	14dBm	14dBm	14dBm				
199	00C7	865,4875	14dBm	14dBm	14dBm		14dBm			
200	00C8	865,5000	14dBm	14dBm	14dBm	14dBm		14dBm		14dBm
201	00C9	865,5125	14dBm	14dBm	14dBm					
202	00CA	865,5250	14dBm	14dBm	14dBm	14dBm	14dBm			
203	00CB	865,5375	14dBm	14dBm	14dBm				14dBm	
204	00CC	865,5500	14dBm	14dBm	14dBm	14dBm		14dBm		
205	00CD	865,5625	14dBm	14dBm	14dBm		14dBm			
206	00CE	865,5750	14dBm	14dBm	14dBm	14dBm				
207	00CF	865,5875	14dBm	14dBm	14dBm					
208	00D0	865,6000	14dBm	14dBm	14dBm	14dBm	14dBm	14dBm		
209	00D1	865,6125	14dBm	14dBm	14dBm				14dBm	
210	00D2	865,6250	14dBm	14dBm	14dBm	14dBm				
211	00D3	865,6375	14dBm	14dBm	14dBm		14dBm			
212	00D4	865,6500	14dBm	14dBm	14dBm	14dBm		14dBm		
213	00D5	865,6625	14dBm	14dBm	14dBm					
214	00D6	865,6750	14dBm	14dBm	14dBm	14dBm	14dBm			
215	00D7	865,6875	14dBm	14dBm	14dBm				14dBm	
216	00D8	865,7000	14dBm	14dBm	14dBm	14dBm		14dBm		14dBm
217	00D9	865,7125	14dBm	14dBm	14dBm		14dBm			

Channel		Freq.	1,2 kbps	2,4 kbps	4,8 kbps	9,6 kbps	19,2 kbps	38,4 kbps	57,6 kbps	115,2 kbps
dec.	hex.									
218	00DA	865,7250	14dBm	14dBm	14dBm	14dBm				
219	00DB	865,7375	14dBm	14dBm	14dBm					
220	00DC	865,7500	14dBm	14dBm	14dBm	14dBm	14dBm	14dBm		
221	00DD	865,7625	14dBm	14dBm	14dBm				14dBm	
222	00DE	865,7750	14dBm	14dBm	14dBm	14dBm				
223	00DF	865,7875	14dBm	14dBm	14dBm		14dBm			
224	00E0	865,8000	14dBm	14dBm	14dBm	14dBm		14dBm		
225	00E1	865,8125	14dBm	14dBm	14dBm					
226	00E2	865,8250	14dBm	14dBm	14dBm	14dBm	14dBm			
227	00E3	865,8375	14dBm	14dBm	14dBm				14dBm	
228	00E4	865,8500	14dBm	14dBm	14dBm	14dBm		14dBm		
229	00E5	865,8625	14dBm	14dBm	14dBm		14dBm			
230	00E6	865,8750	14dBm	14dBm	14dBm	14dBm				
231	00E7	865,8875	14dBm	14dBm	14dBm					
232	00E8	865,9000	14dBm	14dBm	14dBm	14dBm	14dBm	14dBm		14dBm
233	00E9	865,9125	14dBm	14dBm	14dBm				14dBm	
234	00EA	865,9250	14dBm	14dBm	14dBm	14dBm				
235	00EB	865,9375	14dBm	14dBm	14dBm		14dBm			
236	00EC	865,9500	14dBm	14dBm	14dBm	14dBm		14dBm		
237	00ED	865,9625	14dBm	14dBm	14dBm					
238	00EE	865,9750	14dBm	14dBm	14dBm	14dBm	14dBm			
239	00EF	865,9875	14dBm	14dBm	14dBm				14dBm	
240	00F0	866,0000	14dBm	14dBm	14dBm	14dBm		14dBm		
241	00F1	866,0125	14dBm	14dBm	14dBm		14dBm			
242	00F2	866,0250	14dBm	14dBm	14dBm	14dBm				
243	00F3	866,0375	14dBm	14dBm	14dBm					
244	00F4	866,0500	14dBm	14dBm	14dBm	14dBm	14dBm	14dBm		
245	00F5	866,0625	14dBm	14dBm	14dBm				14dBm	
246	00F6	866,0750	14dBm	14dBm	14dBm	14dBm				
247	00F7	866,0875	14dBm	14dBm	14dBm		14dBm			
248	00F8	866,1000	14dBm	14dBm	14dBm	14dBm		14dBm		14dBm
249	00F9	866,1125	14dBm	14dBm	14dBm					
250	00FA	866,1250	14dBm	14dBm	14dBm	14dBm	14dBm			
251	00FB	866,1375	14dBm	14dBm	14dBm				14dBm	
252	00FC	866,1500	14dBm	14dBm	14dBm	14dBm		14dBm		
253	00FD	866,1625	14dBm	14dBm	14dBm		14dBm			
254	00FE	866,1750	14dBm	14dBm	14dBm	14dBm				
255	00FF	866,1875	14dBm	14dBm	14dBm					
256	0100	866,2000	14dBm	14dBm	14dBm	14dBm	14dBm	14dBm		
257	0101	866,2125	14dBm	14dBm	14dBm				14dBm	
258	0102	866,2250	14dBm	14dBm	14dBm	14dBm				
259	0103	866,2375	14dBm	14dBm	14dBm		14dBm			
260	0104	866,2500	14dBm	14dBm	14dBm	14dBm		14dBm		
261	0105	866,2625	14dBm	14dBm	14dBm					

Channel		Freq.	1,2 kbps	2,4 kbps	4,8 kbps	9,6 kbps	19,2 kbps	38,4 kbps	57,6 kbps	115,2 kbps
dec.	hex.									
262	0106	866,2750	14dBm	14dBm	14dBm	14dBm	14dBm			
263	0107	866,2875	14dBm	14dBm	14dBm				14dBm	
264	0108	866,3000	14dBm	14dBm	14dBm	14dBm		14dBm		14dBm
265	0109	866,3125	14dBm	14dBm	14dBm		14dBm			
266	010A	866,3250	14dBm	14dBm	14dBm	14dBm				
267	010B	866,3375	14dBm	14dBm	14dBm					
268	010C	866,3500	14dBm	14dBm	14dBm	14dBm	14dBm	14dBm		
269	010D	866,3625	14dBm	14dBm	14dBm				14dBm	
270	010E	866,3750	14dBm	14dBm	14dBm	14dBm				
271	010F	866,3875	14dBm	14dBm	14dBm		14dBm			
272	0110	866,4000	14dBm	14dBm	14dBm	14dBm		14dBm		
273	0111	866,4125	14dBm	14dBm	14dBm					
274	0112	866,4250	14dBm	14dBm	14dBm	14dBm	14dBm			
275	0113	866,4375	14dBm	14dBm	14dBm				14dBm	
276	0114	866,4500	14dBm	14dBm	14dBm	14dBm		14dBm		
277	0115	866,4625	14dBm	14dBm	14dBm		14dBm			
278	0116	866,4750	14dBm	14dBm	14dBm	14dBm				
279	0117	866,4875	14dBm	14dBm	14dBm					
280	0118	866,5000	14dBm	14dBm	14dBm	14dBm	14dBm	14dBm		14dBm
281	0119	866,5125	14dBm	14dBm	14dBm				14dBm	
282	011A	866,5250	14dBm	14dBm	14dBm	14dBm				
283	011B	866,5375	14dBm	14dBm	14dBm		14dBm			
284	011C	866,5500	14dBm	14dBm	14dBm	14dBm		14dBm		
285	011D	866,5625	14dBm	14dBm	14dBm					
286	011E	866,5750	14dBm	14dBm	14dBm	14dBm	14dBm			
287	011F	866,5875	14dBm	14dBm	14dBm				14dBm	
288	0120	866,6000	14dBm	14dBm	14dBm	14dBm		14dBm		
289	0121	866,6125	14dBm	14dBm	14dBm		14dBm			
290	0122	866,6250	14dBm	14dBm	14dBm	14dBm				
291	0123	866,6375	14dBm	14dBm	14dBm					
292	0124	866,6500	14dBm	14dBm	14dBm	14dBm	14dBm	14dBm		
293	0125	866,6625	14dBm	14dBm	14dBm				14dBm	
294	0126	866,6750	14dBm	14dBm	14dBm	14dBm				
295	0127	866,6875	14dBm	14dBm	14dBm		14dBm			
296	0128	866,7000	14dBm	14dBm	14dBm	14dBm		14dBm		14dBm
297	0129	866,7125	14dBm	14dBm	14dBm					
298	012A	866,7250	14dBm	14dBm	14dBm	14dBm	14dBm			
299	012B	866,7375	14dBm	14dBm	14dBm				14dBm	
300	012C	866,7500	14dBm	14dBm	14dBm	14dBm		14dBm		
301	012D	866,7625	14dBm	14dBm	14dBm		14dBm			
302	012E	866,7750	14dBm	14dBm	14dBm	14dBm				
303	012F	866,7875	14dBm	14dBm	14dBm					
304	0130	866,8000	14dBm	14dBm	14dBm	14dBm	14dBm	14dBm		
305	0131	866,8125	14dBm	14dBm	14dBm				14dBm	

Channel		Freq.	1,2 kbps	2,4 kbps	4,8 kbps	9,6 kbps	19,2 kbps	38,4 kbps	57,6 kbps	115,2 kbps
dec.	hex.									
306	0132	866,8250	14dBm	14dBm	14dBm	14dBm				
307	0133	866,8375	14dBm	14dBm	14dBm		14dBm			
308	0134	866,8500	14dBm	14dBm	14dBm	14dBm		14dBm		
309	0135	866,8625	14dBm	14dBm	14dBm					
310	0136	866,8750	14dBm	14dBm	14dBm	14dBm	14dBm			
311	0137	866,8875	14dBm	14dBm	14dBm				14dBm	
312	0138	866,9000	14dBm	14dBm	14dBm	14dBm		14dBm		14dBm
313	0139	866,9125	14dBm	14dBm	14dBm		14dBm			
314	013A	866,9250	14dBm	14dBm	14dBm	14dBm				
315	013B	866,9375	14dBm	14dBm	14dBm					
316	013C	866,9500	14dBm	14dBm	14dBm	14dBm	14dBm	14dBm		
317	013D	866,9625	14dBm	14dBm	14dBm				14dBm	
318	013E	866,9750	14dBm	14dBm	14dBm	14dBm				
319	013F	866,9875	14dBm	14dBm	14dBm		14dBm			
320	0140	867,0000	14dBm	14dBm	14dBm	14dBm		14dBm		
321	0141	867,0125	14dBm	14dBm	14dBm					
322	0142	867,0250	14dBm	14dBm	14dBm	14dBm	14dBm			
323	0143	867,0375	14dBm	14dBm	14dBm				14dBm	
324	0144	867,0500	14dBm	14dBm	14dBm	14dBm		14dBm		
325	0145	867,0625	14dBm	14dBm	14dBm		14dBm			
326	0146	867,0750	14dBm	14dBm	14dBm	14dBm				
327	0147	867,0875	14dBm	14dBm	14dBm					
328	0148	867,1000	14dBm	14dBm	14dBm	14dBm	14dBm	14dBm		14dBm
329	0149	867,1125	14dBm	14dBm	14dBm				14dBm	
330	014A	867,1250	14dBm	14dBm	14dBm	14dBm				
331	014B	867,1375	14dBm	14dBm	14dBm		14dBm			
332	014C	867,1500	14dBm	14dBm	14dBm	14dBm		14dBm		
333	014D	867,1625	14dBm	14dBm	14dBm					
334	014E	867,1750	14dBm	14dBm	14dBm	14dBm	14dBm			
335	014F	867,1875	14dBm	14dBm	14dBm				14dBm	
336	0150	867,2000	14dBm	14dBm	14dBm	14dBm		14dBm		
337	0151	867,2125	14dBm	14dBm	14dBm		14dBm			
338	0152	867,2250	14dBm	14dBm	14dBm	14dBm				
339	0153	867,2375	14dBm	14dBm	14dBm					
340	0154	867,2500	14dBm	14dBm	14dBm	14dBm	14dBm	14dBm		
341	0155	867,2625	14dBm	14dBm	14dBm				14dBm	
342	0156	867,2750	14dBm	14dBm	14dBm	14dBm				
343	0157	867,2875	14dBm	14dBm	14dBm		14dBm			
344	0158	867,3000	14dBm	14dBm	14dBm	14dBm		14dBm		14dBm
345	0159	867,3125	14dBm	14dBm	14dBm					
346	015A	867,3250	14dBm	14dBm	14dBm	14dBm	14dBm			
347	015B	867,3375	14dBm	14dBm	14dBm				14dBm	
348	015C	867,3500	14dBm	14dBm	14dBm	14dBm		14dBm		
349	015D	867,3625	14dBm	14dBm	14dBm		14dBm			



Channel		Freq.	1,2 kbps	2,4 kbps	4,8 kbps	9,6 kbps	19,2 kbps	38,4 kbps	57,6 kbps	115,2 kbps
dec.	hex.									
350	015E	867,3750	14dBm	14dBm	14dBm	14dBm				
351	015F	867,3875	14dBm	14dBm	14dBm					
352	0160	867,4000	14dBm	14dBm	14dBm	14dBm	14dBm	14dBm		
353	0161	867,4125	14dBm	14dBm	14dBm				14dBm	
354	0162	867,4250	14dBm	14dBm	14dBm	14dBm				
355	0163	867,4375	14dBm	14dBm	14dBm		14dBm			
356	0164	867,4500	14dBm	14dBm	14dBm	14dBm		14dBm		
357	0165	867,4625	14dBm	14dBm	14dBm					
358	0166	867,4750	14dBm	14dBm	14dBm	14dBm	14dBm			
359	0167	867,4875	14dBm	14dBm	14dBm				14dBm	
360	0168	867,5000	14dBm	14dBm	14dBm	14dBm		14dBm		14dBm
361	0169	867,5125	14dBm	14dBm	14dBm		14dBm			
362	016A	867,5250	14dBm	14dBm	14dBm	14dBm				
363	016B	867,5375	14dBm	14dBm	14dBm					
364	016C	867,5500	14dBm	14dBm	14dBm	14dBm	14dBm	14dBm		
365	016D	867,5625	14dBm	14dBm	14dBm				14dBm	
366	016E	867,5750	14dBm	14dBm	14dBm	14dBm				
367	016F	867,5875	14dBm	14dBm	14dBm		14dBm			
368	0170	867,6000	14dBm	14dBm	14dBm	14dBm		14dBm		
369	0171	867,6125	14dBm	14dBm	14dBm					
370	0172	867,6250	14dBm	14dBm	14dBm	14dBm	14dBm			
371	0173	867,6375	14dBm	14dBm	14dBm				14dBm	
372	0174	867,6500	14dBm	14dBm	14dBm	14dBm		14dBm		
373	0175	867,6625	14dBm	14dBm	14dBm		14dBm			
374	0176	867,6750	14dBm	14dBm	14dBm	14dBm				
375	0177	867,6875	14dBm	14dBm	14dBm					
376	0178	867,7000	14dBm	14dBm	14dBm	14dBm	14dBm	14dBm		14dBm
377	0179	867,7125	14dBm	14dBm	14dBm				14dBm	
378	017A	867,7250	14dBm	14dBm	14dBm	14dBm				
379	017B	867,7375	14dBm	14dBm	14dBm		14dBm			
380	017C	867,7500	14dBm	14dBm	14dBm	14dBm		14dBm		
381	017D	867,7625	14dBm	14dBm	14dBm					
382	017E	867,7750	14dBm	14dBm	14dBm	14dBm	14dBm			
383	017F	867,7875	14dBm	14dBm	14dBm				14dBm	
384	0180	867,8000	14dBm	14dBm	14dBm	14dBm		14dBm		
385	0181	867,8125	14dBm	14dBm	14dBm		14dBm			
386	0182	867,8250	14dBm	14dBm	14dBm	14dBm				
387	0183	867,8375	14dBm	14dBm	14dBm					
388	0184	867,8500	14dBm	14dBm	14dBm	14dBm	14dBm	14dBm		
389	0185	867,8625	14dBm	14dBm	14dBm				14dBm	
390	0186	867,8750	14dBm	14dBm	14dBm	14dBm				
391	0187	867,8875	14dBm	14dBm	14dBm		14dBm			
392	0188	867,9000	14dBm	14dBm	14dBm	14dBm		14dBm		14dBm
393	0189	867,9125	14dBm	14dBm	14dBm					

Channel		Freq.	1,2 kbps	2,4 kbps	4,8 kbps	9,6 kbps	19,2 kbps	38,4 kbps	57,6 kbps	115,2 kbps
dec.	hex.									
394	018A	867,9250	14dBm	14dBm	14dBm	14dBm	14dBm			
395	018B	867,9375	14dBm	14dBm	14dBm				14dBm	
396	018C	867,9500	14dBm	14dBm	14dBm	14dBm		14dBm		
397	018D	867,9625	14dBm	14dBm	14dBm		14dBm			
398	018E	867,9750	14dBm	14dBm	14dBm	14dBm				
399	018F	867,9875	14dBm	14dBm	14dBm					
400	0190	868,0000	14dBm	14dBm	14dBm	14dBm	14dBm	14dBm		
401	0191	868,0125	14dBm	14dBm	14dBm				14dBm	
402	0192	868,0250	14dBm	14dBm	14dBm	14dBm				
403	0193	868,0375	14dBm	14dBm	14dBm		14dBm			
404	0194	868,0500	14dBm	14dBm	14dBm	14dBm		14dBm		
405	0195	868,0625	14dBm	14dBm	14dBm					
406	0196	868,0750	14dBm	14dBm	14dBm	14dBm	14dBm			
407	0197	868,0875	14dBm	14dBm	14dBm				14dBm	
408	0198	868,1000	14dBm	14dBm	14dBm	14dBm		14dBm		14dBm
409	0199	868,1125	14dBm	14dBm	14dBm		14dBm			
410	019A	868,1250	14dBm	14dBm	14dBm	14dBm				
411	019B	868,1375	14dBm	14dBm	14dBm					
412	019C	868,1500	14dBm	14dBm	14dBm	14dBm	14dBm	14dBm		
413	019D	868,1625	14dBm	14dBm	14dBm				14dBm	
414	019E	868,1750	14dBm	14dBm	14dBm	14dBm				
415	019F	868,1875	14dBm	14dBm	14dBm		14dBm			
416	01A0	868,2000	14dBm	14dBm	14dBm	14dBm		14dBm		
417	01A1	868,2125	14dBm	14dBm	14dBm					
418	01A2	868,2250	14dBm	14dBm	14dBm	14dBm	14dBm			
419	01A3	868,2375	14dBm	14dBm	14dBm				14dBm	
420	01A4	868,2500	14dBm	14dBm	14dBm	14dBm		14dBm		
421	01A5	868,2625	14dBm	14dBm	14dBm		14dBm			
422	01A6	868,2750	14dBm	14dBm	14dBm	14dBm				
423	01A7	868,2875	14dBm	14dBm	14dBm					
424	01A8	868,3000	14dBm	14dBm	14dBm	14dBm	14dBm	14dBm		14dBm
425	01A9	868,3125	14dBm	14dBm	14dBm				14dBm	
426	01AA	868,3250	14dBm	14dBm	14dBm	14dBm				
427	01AB	868,3375	14dBm	14dBm	14dBm		14dBm			
428	01AC	868,3500	14dBm	14dBm	14dBm	14dBm		14dBm		
429	01AD	868,3625	14dBm	14dBm	14dBm					
430	01AE	868,3750	14dBm	14dBm	14dBm	14dBm	14dBm			
431	01AF	868,3875	14dBm	14dBm	14dBm				14dBm	
432	01B0	868,4000	14dBm	14dBm	14dBm	14dBm		14dBm		
433	01B1	868,4125	14dBm	14dBm	14dBm		14dBm			
434	01B2	868,4250	14dBm	14dBm	14dBm	14dBm				
435	01B3	868,4375	14dBm	14dBm	14dBm					
436	01B4	868,4500	14dBm	14dBm	14dBm	14dBm	14dBm	14dBm		
437	01B5	868,4625	14dBm	14dBm	14dBm				14dBm	

Channel		Freq.	1,2 kbps	2,4 kbps	4,8 kbps	9,6 kbps	19,2 kbps	38,4 kbps	57,6 kbps	115,2 kbps
dec.	hex.									
438	01B6	868,4750	14dBm	14dBm	14dBm	14dBm				
439	01B7	868,4875	14dBm	14dBm	14dBm		14dBm			
440	01B8	868,5000	14dBm	14dBm	14dBm	14dBm		14dBm		14dBm
441	01B9	868,5125	14dBm	14dBm	14dBm					
442	01BA	868,5250	14dBm	14dBm	14dBm	14dBm	14dBm			
443	01BB	868,5375	14dBm	14dBm	14dBm				14dBm	
444	01BC	868,5500	14dBm	14dBm	14dBm	14dBm		14dBm		
445	01BD	868,5625	14dBm	14dBm	14dBm		14dBm			
446	01BE	868,5750	14dBm	14dBm	14dBm	14dBm				
447	01BF	868,5875	14dBm	14dBm	14dBm					
448	01C0	868,6000	14dBm	14dBm	14dBm	14dBm	14dBm	14dBm		
449	01C1	868,6125	14dBm	14dBm	14dBm				14dBm	
450	01C2	868,6250	14dBm	14dBm	14dBm	14dBm				
451	01C3	868,6375	14dBm	14dBm	14dBm		14dBm			
452	01C4	868,6500	14dBm	14dBm	14dBm	14dBm		14dBm		
453	01C5	868,6625	14dBm	14dBm	14dBm					
454	01C6	868,6750	14dBm	14dBm	14dBm	14dBm	14dBm			
455	01C7	868,6875	14dBm	14dBm	14dBm				14dBm	
456	01C8	868,7000	14dBm	14dBm	14dBm	14dBm		14dBm		14dBm
457	01C9	868,7125	14dBm	14dBm	14dBm		14dBm			
458	01CA	868,7250	14dBm	14dBm	14dBm	14dBm				
459	01CB	868,7375	14dBm	14dBm	14dBm					
460	01CC	868,7500	14dBm	14dBm	14dBm	14dBm	14dBm	14dBm		
461	01CD	868,7625	14dBm	14dBm	14dBm				14dBm	
462	01CE	868,7750	14dBm	14dBm	14dBm	14dBm				
463	01CF	868,7875	14dBm	14dBm	14dBm		14dBm			
464	01D0	868,8000	14dBm	14dBm	14dBm	14dBm		14dBm		
465	01D1	868,8125	14dBm	14dBm	14dBm					
466	01D2	868,8250	14dBm	14dBm	14dBm	14dBm	14dBm			
467	01D3	868,8375	14dBm	14dBm	14dBm				14dBm	
468	01D4	868,8500	14dBm	14dBm	14dBm	14dBm		14dBm		
469	01D5	868,8625	14dBm	14dBm	14dBm		14dBm			
470	01D6	868,8750	14dBm	14dBm	14dBm	14dBm				
471	01D7	868,8875	14dBm	14dBm	14dBm					
472	01D8	868,9000	14dBm	14dBm	14dBm	14dBm	14dBm	14dBm		14dBm
473	01D9	868,9125	14dBm	14dBm	14dBm				14dBm	
474	01DA	868,9250	14dBm	14dBm	14dBm	14dBm				
475	01DB	868,9375	14dBm	14dBm	14dBm		14dBm			
476	01DC	868,9500	14dBm	14dBm	14dBm	14dBm		14dBm		
477	01DD	868,9625	14dBm	14dBm	14dBm					
478	01DE	868,9750	14dBm	14dBm	14dBm	14dBm	14dBm			
479	01DF	868,9875	14dBm	14dBm	14dBm				14dBm	
480	01E0	869,0000	14dBm	14dBm	14dBm	14dBm		14dBm		
481	01E1	869,0125	14dBm	14dBm	14dBm		14dBm			

Channel		Freq.	1,2 kbps	2,4 kbps	4,8 kbps	9,6 kbps	19,2 kbps	38,4 kbps	57,6 kbps	115,2 kbps
dec.	hex.									
482	01E2	869,0250	14dBm	14dBm	14dBm	14dBm				
483	01E3	869,0375	14dBm	14dBm	14dBm					
484	01E4	869,0500	14dBm	14dBm	14dBm	14dBm	14dBm	14dBm		
485	01E5	869,0625	14dBm	14dBm	14dBm				14dBm	
486	01E6	869,0750	14dBm	14dBm	14dBm	14dBm				
487	01E7	869,0875	14dBm	14dBm	14dBm		14dBm			
488	01E8	869,1000	14dBm	14dBm	14dBm	14dBm		14dBm		14dBm
489	01E9	869,1125	14dBm	14dBm	14dBm					
490	01EA	869,1250	14dBm	14dBm	14dBm	14dBm	14dBm			
491	01EB	869,1375	14dBm	14dBm	14dBm				14dBm	
492	01EC	869,1500	14dBm	14dBm	14dBm	14dBm		14dBm		
493	01ED	869,1625	14dBm	14dBm	14dBm		14dBm			
494	01EE	869,1750	14dBm	14dBm	14dBm	14dBm				
495	01EF	869,1875	14dBm	14dBm	14dBm					
496	01F0	869,2000	14dBm	14dBm	14dBm	14dBm	14dBm	14dBm		
497	01F1	869,2125	14dBm	14dBm	14dBm				14dBm	
498	01F2	869,2250	14dBm	14dBm	14dBm	14dBm				
499	01F3	869,2375	14dBm	14dBm	14dBm		14dBm			
500	01F4	869,2500	14dBm	14dBm	14dBm	14dBm		14dBm		
501	01F5	869,2625	14dBm	14dBm	14dBm					
502	01F6	869,2750	14dBm	14dBm	14dBm	14dBm	14dBm			
503	01F7	869,2875	14dBm	14dBm	14dBm				14dBm	
504	01F8	869,3000	14dBm	14dBm	14dBm	14dBm		14dBm		14dBm
505	01F9	869,3125	14dBm	14dBm	14dBm		14dBm			
506	01FA	869,3250	14dBm	14dBm	14dBm	14dBm				
507	01FB	869,3375	14dBm	14dBm	14dBm					
508	01FC	869,3500	14dBm	14dBm	14dBm	14dBm	14dBm	14dBm		
509	01FD	869,3625	14dBm	14dBm	14dBm					
510	01FE	869,3750	14dBm	14dBm	14dBm	14dBm				
511	01FF	869,3875	14dBm	14dBm	14dBm					
512	0200	869,4000								
513	0201	869,4125	21dBm	21dBm	21dBm					
514	0202	869,4250	21dBm	21dBm	21dBm	21dBm				
515	0203	869,4375	23dBm	23dBm	23dBm					
516	0204	869,4500	23dBm	23dBm	23dBm	23dBm	23dBm	23dBm		
517	0205	869,4625	27dBm	27dBm	27dBm				27dBm	
518	0206	869,4750	27dBm	27dBm	27dBm	27dBm		27dBm		
519	0207	869,4875	27dBm	27dBm	27dBm		27dBm			
520	0208	869,5000	27dBm	27dBm	27dBm	27dBm		27dBm		
521	0209	869,5125	27dBm	27dBm	27dBm					
522	020A	869,5250	27dBm	27dBm	27dBm	27dBm	27dBm	27dBm	27dBm	27dBm
523	020B	869,5375	27dBm	27dBm	27dBm					
524	020C	869,5500	27dBm	27dBm	27dBm	27dBm		27dBm		
525	020D	869,5625	27dBm	27dBm	27dBm		27dBm			

Channel		Freq.	1,2 kbps	2,4 kbps	4,8 kbps	9,6 kbps	19,2 kbps	38,4 kbps	57,6 kbps	115,2 kbps
dec.	hex.									
526	020E	869,5750	27dBm	27dBm	27dBm	27dBm		27dBm		
527	020F	869,5875	27dBm	27dBm	27dBm				27dBm	
528	0210	869,6000	23dBm	23dBm	23dBm	23dBm	23dBm	23dBm		
529	0211	869,6125	23dBm	23dBm	23dBm					
530	0212	869,6250	21dBm	21dBm	21dBm	21dBm				
531	0213	869,6375	21dBm	21dBm	21dBm					
532	0214	869,6500								
533	0215	869,6625	14dBm	14dBm	14dBm					
534	0216	869,6750	14dBm	14dBm	14dBm	14dBm				
535	0217	869,6875	14dBm	14dBm	14dBm					
536	0218	869,7000	14dBm	14dBm	14dBm	14dBm	14dBm	14dBm		
537	0219	869,7125	14dBm	14dBm	14dBm				14dBm	
538	021A	869,7250	14dBm	14dBm	14dBm	14dBm				
539	021B	869,7375	14dBm	14dBm	14dBm		14dBm			
540	021C	869,7500	14dBm	14dBm	14dBm	14dBm		14dBm		14dBm
541	021D	869,7625	14dBm	14dBm	14dBm					
542	021E	869,7750	14dBm	14dBm	14dBm	14dBm	14dBm			
543	021F	869,7875	14dBm	14dBm	14dBm				14dBm	
544	0220	869,8000	14dBm	14dBm	14dBm	14dBm		14dBm		
545	0221	869,8125	14dBm	14dBm	14dBm		14dBm			
546	0222	869,8250	14dBm	14dBm	14dBm	14dBm				
547	0223	869,8375	14dBm	14dBm	14dBm					
548	0224	869,8500	14dBm	14dBm	14dBm	14dBm	14dBm	14dBm		
549	0225	869,8625	14dBm	14dBm	14dBm				14dBm	
550	0226	869,8750	14dBm	14dBm	14dBm	14dBm				
551	0227	869,8875	14dBm	14dBm	14dBm		14dBm			
552	0228	869,9000	14dBm	14dBm	14dBm	14dBm		14dBm		
553	0229	869,9125	14dBm	14dBm	14dBm					
554	022A	869,9250	14dBm	14dBm	14dBm	14dBm	14dBm			
555	022B	869,9375	14dBm	14dBm	14dBm				14dBm	
556	022C	869,9500	14dBm	14dBm	14dBm	14dBm		14dBm		
557	022D	869,9625	14dBm	14dBm	14dBm		14dBm			
558	022E	869,9750	14dBm	14dBm	14dBm	14dBm				
559	022F	869,9875	14dBm	14dBm	14dBm					
560	0230	870,0000								

## AT registers table

REGISTER	DESIGNATION	DESIGNATION VALUES	DEFAULT VALUES	READ /WRITE
S000	Application1	OPERATING_MODE_UART2RF_BRIDGE = 0x10, OPERATING_MODE_MODBUS_MASTER_ONLY = 0x20, OPERATING_MODE_MODBUS_SLAVE_ONLY = 0x40, OPERATING_MODE_UART2SFX_BRIDGE = 0x50, OPERATING_MODE_UART_AND_RF_TO_SFX_BRIDGE = 0x60,  OPERATING_MODE_PINGPONG_MASTER_INIT = 0x00, OPERATING_MODE_PINGPONG_SLAVE_INIT = 0x01, OPERATING_MODE_SPECTRUM_ANALYSER_INIT = 0x0A, OPERATING_MODE_PURE_CARRIER_INIT = 0x04, OPERATING_MODE_CONTINUOUS_RECEPTION_INIT = 0x02, OPERATING_MODE_RANDOM_MODULATED_CARRIER_INIT = 0x07, OPERATING_MODE_INFINITE_RDM_MODULATED_CARRIER_INIT = 0x08,	XX	R/W
S001	Application2		0x28	R
S002	Radio_ARM_Channel LSB	1- 560	0x0A	R/W
S003	Radio_ARM_Channel MSB		0x02	R/W
S004	Radio_OutputPowerEmission	RADIO_OUTPUT_POWER_IS_TBD = 0xFF, RADIO_OUTPUT_POWER_IS_REGULATORY_LIMIT = 0x00, RADIO_OUTPUT_POWER_IS_0dBm = 0x01, RADIO_OUTPUT_POWER_IS_5dBm = 0x02, RADIO_OUTPUT_POWER_IS_7dBm = 0x03, RADIO_OUTPUT_POWER_IS_10dBm = 0x04, RADIO_OUTPUT_POWER_IS_12dBm = 0x05, RADIO_OUTPUT_POWER_IS_14dBm = 0x06, RADIO_OUTPUT_POWER_IS_20dBm = 0x07, RADIO_OUTPUT_POWER_IS_23dBm = 0x08, RADIO_OUTPUT_POWER_IS_27dBm = 0x09,	0x00	
S005	SecureMode_DestAddrLSB		0x44	NC
S006	SecureMode_DestAddrMSB		0x44	NC
S007	SecureMode_LocalAddr		0x55	NC
S008	Radio_Application1	RADIO_BAUDRATE_UNDEFINED = 0xFF, RADIO_BAUDRATE_R100_DBPSK = 0x00, //Sigfox RADIO_BAUDRATE_R1200_2GFSK = 0x01, //NB RADIO_BAUDRATE_R2400_2GFSK = 0x02, //NB RADIO_BAUDRATE_R4800_4GFSK = 0x03, //NB RADIO_BAUDRATE_R9600_4GFSK = 0x04, //WB RADIO_BAUDRATE_R19200_4GFSK = 0x05, //WB RADIO_BAUDRATE_R38400_4GFSK = 0x06, //WB RADIO_BAUDRATE_R57600_4GFSK = 0x07, //WB RADIO_BAUDRATE_R115200_4GFSK = 0x08, //WB  RADIO_BAUDRATE_R38400_2GFSK = 0x09, //WB compatibility RADIO_BAUDRATE_R19200_2GFSK = 0x0A, //WB compatibility RADIO_BAUDRATE_R9600_2GFSK = 0x0B, //WB compatibility	0x01	R/W
S009	Radio_Tests		0x00	NC
S010	SecureMode_RepeaterAddrLSB		0x77	NC
S011	SecureMode_RepeaterAddrMSB		0x77	NC
S012	Serial_Baudrate	SERIAL_BAUDRATE_1200=0x00, SERIAL_BAUDRATE_2400=0x01, SERIAL_BAUDRATE_4800=0x02, SERIAL_BAUDRATE_9600=0x03, SERIAL_BAUDRATE_19200=0x04, SERIAL_BAUDRATE_38400=0x05, SERIAL_BAUDRATE_57600=0x06, SERIAL_BAUDRATE_115200=0x07, SERIAL_BAUDRATE_230400=0x08,	0x04	R/W
S013	Serial_Databit	DATABITS_7=0x07, DATABITS_8=0x08,	0x08	R/W

S014	Serial_Parity	PARITY_ODD_DISABLE=0x00, PARITY_ODD_ENABLE=0x01, PARITY_EVEN_DISABLE=0x02, PARITY_EVEN_ENABLE=0x03,	0x02	R/W
S015	Serial_Stopbit	STOPBIT_1=0x01, STOPBIT_2=0x02,	0x01	R/W
S016	Serial_FlowControl	FLOWCONTROL_NONE=0x00, FLOWCONTROL_CTSRTSBUFFERMODE=0x01, <del>FLOWCONTROL_RTS1=0x02,</del> <del>FLOWCONTROL_RTS0=0x03,</del> <del>FLOWCONTROL_CTSRTSCMDLED=0x04,</del> <del>FLOWCONTROL_CTSRTSRADIOMODE=0x05,</del> <del>FLOWCONTROL_OUTCMDRS485=0x06,</del>	0x00	R/W
S017	Radio_DelayBeforeTX	0 - 255 ms	0x00	R/W
S018	Serial_DelayAfterTxSerialLSB		0x00	R/W
S019	Serial_DelayAfterTxSerialMSB		0x00	R/W
S020	Bridge_Settings	unsigned char _AllTraffic:1; unsigned char _TxRF_PacketMode:1; unsigned char _RxRF_PacketMode:1; unsigned char _undefined:5;	0x07	R/W
S021	SecureMode_WaitingTimeBase		0x0	NC
S022	SecureMode_TxRetry		0x0	NC
S023	Radio_DelayAfterTx	0 - 255 ms	0x00	R/W
S024	SleepMode_DelayBeforeSleep		0x0	NC
S025	OnBoardDevices	unsigned char _TxRxLEDON unsigned char _TxRxLEDOFF unsigned char _RxPacket unsigned char _TxPacket unsigned char _CS_LBT unsigned char _CS_RX unsigned char _CsLEDON unsigned char _CS_PWM	0x02	R/W
S026	Radio_ARM_BackUpChannel LSB		0x40	R/W
S027	Radio_ARM_BackUpChannel MSB	1- 560	0x00	R/W
S028	Application9		0x0	NC
S029	Application8		0x0	NC
S030	Application5		0x0	NC
S031	Bridge_DelayWaitForReceive		0x0	NC
S032	Radio_RSSIlevel	-95	0xA1	R/W
S033	Misc_DelayToAcceptCommandMode		0x0	NC
S034	Application3		0x0	NC
S035	Application4		0x0	NC
S036	Bridge_TimeOutRadioReception		0x0	NC
S037	Radio_EncryptionKeyCode1		0x0	NC
S038	Radio_EncryptionKeyCode2		0x0	NC
S039	Radio_EncryptionKeyCode3		0x0	NC
S040	Application6		0x0	NC
S041	Radio_PreambleCode		0x0	NC
S042	Application7		0x0	NC
S043	TestMode_DelayLSB		0xF0	NC
S044	TestMode_DelayMSB		0x00	NC
S045	undefined08		0x00	NC
S046	SecureMode_AsciiCodeACK		0x0	NC
S047	SecureMode_AsciiCodeNACK		0x0	NC
S048	undefined09		0x10	NC
S049	TestMode_RadioControl		0x0	NC

S050	TestMode_TxDelay		0x0	NC
S051	TestMode_RxDelay		0x0	NC
S052	Radio_TimeOutNoRxLSB		0x00	NC
S053	Radio_TimeOutNoRxMSB		0x00	NC
S054	Serial_RS485ReturnTime		0x00	NC
S055	Serial_Mode		0x01	NC
S056	Radio_LBTDelayBeforeCarrierSense		0x0	NC
S057	Radio_LBTThresholdCarrierSense		0x0	NC
S058	Radio_TxPreamble		0x0	NC
S059	Radio_RxPreamble		0x0	NC
S060	Radio_LOCKCounter		0x0	NC
S061	Radio_UserGain		0x00	R/W
S062	WakeUpSourcePWR	<del>unsigned char _22_RESET :1;</del> <del>unsigned char _21_ANO :1;</del> <del>unsigned char _20_RSSI :1;</del> <del>unsigned char _19_U1TX :1;</del> unsigned char _18_U1RX :1; <del>unsigned char _17_U1RTS :1;</del> <del>unsigned char _16_U1RCTS :1;</del> unsigned char _15_INT0 :1;	0x00	R/W
S063	WakeUpSourceRF	<del>unsigned char _11_RA6 :1;</del> <del>unsigned char _10_SCK2 :1;</del> <del>unsigned char _09_SDO2 :1;</del> <del>unsigned char _08_SCS :1;</del> <del>unsigned char _07_SDI2 :1;</del> <del>unsigned char _06_OSICO :1;</del> <del>unsigned char _05_OSCI :1;</del> <del>unsigned char _NC :1;</del>	0x00	R/W
S064	SleepMode_SleepTimeLSB		0xF4	NC
S065	SleepMode_SleepTimeMSB		0x01	NC
S066	SleepMode_DelayBeforeGoBackSleep	Window awaken in ms	0x01	R/W
S067	undefined14		0x02	NC
S068	Radio_RepeaterChannelEmission		0x04	NC
S069	RepeatMode_Settings	unsigned char _Enabled:1; unsigned char _undefined:7;	0x00	NC
S070	RepeatMode_LocalAddr		0x0	NC
S071	RepeatMode_DestAddr		0x0	NC
S072	RRC_Types[0]	unsigned short int Window:5; unsigned short int MinLevel:4; unsigned short int MaxLevel:4; unsigned short int TxFirstRxLast:1; unsigned short int RandomLevel:1; unsigned short int Enabled:1;	0x00	R/W
S073				
S074	RRC_Types[1]	unsigned short int Window:5; unsigned short int MinLevel:4; unsigned short int MaxLevel:4; unsigned short int TxFirstRxLast:1; unsigned short int RandomLevel:1; unsigned short int Enabled:1;	0x00	R/W
S075				
S076	RRC_Types[2]	unsigned short int Window:5; unsigned short int MinLevel:4; unsigned short int MaxLevel:4; unsigned short int TxFirstRxLast:1; unsigned short int RandomLevel:1; unsigned short int Enabled:1;	0x00	R/W
S077				



S078	RRC_Settings	unsigned char _Enabled :1; unsigned char _MasterMode :1; unsigned char _SlaveMode :1; unsigned char _TxOnTxTypeA :1; unsigned char _TxOnTxTypeB :1; unsigned char _TxOnTxTypeC :1; unsigned char _RefreshSettings:1; unsigned char _LimitedLevel :1;	0xFF	R/W
S079	RRC_undefined		0xFF	R/W
S080	RRC_PushTime		0xFF	R/W
S081	Serial_ReturnTimeTxToRx		0x00	NC
S082	ModbusTimeoutLSB		0xF4	R/W
S083	ModbusTimeoutMSB		0x01	R/W
S084	PBI_TLED_On			R/W
S085	Modbus_MyAddress		0xF0	R/W
S086	MyMACAddressMSB		0x12	R
S087	MyMACAddressUSB		0x34	R
S088	MyMACAddressLSB		0x56	R
S089	Modbus_DestAddress		0x02	R/W
S090	Radio_DestModemAddress		0xFF	R/W
S091	Radio_Chip0Settings		0x00	R/W
S092	Radio_Chip1Settings	unsigned long _LBT :1; unsigned long _AFA :1; unsigned long _LongPreamble :1; unsigned long _WOR_CS:1; unsigned long _FilterChipAdress :1; unsigned long _LongPreambleOnly4WakeUp :1; unsigned long _VariablePacketLength :1; unsigned long _InfinitePacketLength :1;	0x40	R/W
S093	Radio_Chip1Settings	unsigned long _RxToleranceLow :1; unsigned long _PADisabled :1; unsigned long _CCA : 3; unsigned long _Whitening: 1; unsigned long _AttachCRC :1; unsigned long _LongHeader :1;	0xC0	R/W
S094	Radio_Chip1Settings	unsigned long _SyncBytes :3; unsigned long _AttachHeader :1; unsigned long _PreambleBytes :4;	0x0D	R/W
S095	Radio_Chip1Settings	unsigned long _PreambleCode :8;	0x60	R/W
S096	Radio_AddGain		0x00	R/W
S097	Radio_ModemAddress		0x00	R/W
S098	VersionCodeLSB		XX	R
S099	VersionCodeMSB		XX	R